



Zero-Emission Hydrogen Ferry Demonstration Project - Final Report



*Sea Change approaching the San Francisco Ferry Building,
photo courtesy of WETA*

Acknowledgements

This report was prepared in fulfillment of California Air Resources Board Grant CARB-G16-DEMO-05-ZEH2F for the project titled, ‘Zero-Emissions Hydrogen Ferry Demonstration Project.’

SWITCH Maritime recognizes and acknowledges the vitally important contributions of time, energy, and funds from Bay Area Air Quality Management District (Bay Area Air District), California Air Resources Board (CARB), and California Climate Investments (CCI) that were dedicated to helping catalyze this project with initial grant funding and supporting the project along the path to completion. The US Department of Energy Hydrogen Fuel Cell Technologies Office (HFTO) provided partial support for the data analysis activity. SWITCH commends Bay Area Air District, CARB, and CCI for pushing the industry toward advanced technology and cleaner solutions for commercial harbor craft in California waters.

More generally, this project was made possible as a result of the hard work and dedication of many participants, and SWITCH Maritime would like to extend a sincere thanks to all involved parties:



California Air Resources Board

CARB is charged with protecting the public from the harmful effects of air pollution and developing programs and actions to fight climate change. From requirements for clean cars and fuels to adopting innovative solutions to reduce greenhouse gas emissions, California has pioneered a range of effective approaches that have set the standard for effective air and climate programs for the nation, and the world. The grant funding for the SWITCH zero-emissions ferry project was provided by CCI, which is a statewide program a statewide program that puts billions of Cap-and-Trade dollars to work reducing greenhouse gas emissions, strengthening the economy and improving public health and the environment — particularly in disadvantaged communities. CARB's responsibilities & work include:

- Setting the state's air quality standards at levels that protect those at greatest risk - children, older adults and people with lung and heart disease;
- Identifying pollutants that pose the greatest health risks, such as diesel exhaust particles, benzene in gasoline and formaldehyde in consumer products;
- Measuring progress in reducing pollutants utilizing the nation's most extensive air monitoring network;
- Verifying automakers' emissions compliance at CARB's renowned Haagen-Smit Laboratory in El Monte;
- Researching the causes and effects of air pollution problems - and potential solutions - using the best available science and technology;
- Studying the costs and benefits of pollution controls, paying particular attention to individuals and communities most at risk; and
- Leading California's efforts to reduce climate-changing emissions through measures that promote a more energy-efficient and resilient economy.

Bay Area Air Quality Management District

The California Legislature created the Air District in 1955 as the first regional air pollution control agency in the country. The Air District is tasked with regulating stationary sources of air pollution in the nine counties that surround San Francisco Bay: Alameda, Contra Costa, Marin, Napa, San Francisco, San Mateo, Santa Clara, southwestern Solano, and southern Sonoma counties. It is governed by a 24-member Board of Directors composed of locally elected officials from each of the nine Bay Area counties, with the number of board members from each county being proportionate to its population.

As the grant administrator for the Zero-Emissions Hydrogen Ferry Demonstration Project, the Bay Area Air District was responsible for ensuring compliance with California Environmental Quality Act (CEQA) requirements; overseeing project development, administration, reporting, progress monitoring, and invoice validation; facilitating kick-off and monthly meetings; maintaining regular communication with project partners to address challenges and ensure timely completion of milestones; reviewing various project documents such as press releases, progress reports, reimbursement requests, and final reports; and providing guidance and support to project participants to ensure alignment with project objectives and compliance with all relevant requirements.

The Bay Area Air District's Climate Tech Finance program offers loan guarantees to support the purchase and adoption of emerging climate technologies that reduce greenhouse gas emissions for small businesses – specifically for projects that reduce air pollution in the Bay Area. Small businesses can apply for loan guarantees on loans of up to \$20 million, with a maximum guarantee of up to 80 percent and \$5.0 million. The Bay Area Air District also provides technology evaluation and technical assistance to borrowers to evaluate proposed projects, and the program is offered through a partnership with the California Infrastructure and Economic Development Bank (IBank).

Table of Contents

Acknowledgements	2
California Air Resources Board	3
Bay Area Air Quality Management District	3
List of Acronyms	6
List of Figures	8
List of Tables	9
Executive Summary	10
Project Goals and Objectives	11
Project Team	12
Vessel Design	16
Outreach and Education	18
Data Collection and Analysis	23
Methodology	24
Verification of Time Basis:	24
Tank Pressure Measurements:.....	25
Fuel Cell Power Measurements:.....	27
Ferry Specification	28
Hydrogen Storage.....	29
Fuel Cells	30
Batteries	33
Electric Propulsion System	34
Project Schedule and Costs	35
Pre-SWITCH Involvement.....	36
SWITCH Purchase Agreement & Loan to GGZEM to Construction Vessel.....	36
Amended SWITCH Purchase Agreement & Transfer of Vessel Ownership	36
Recontracting	37
Vessel Completion	39
Construction at Bay Ship & Yacht shipyard	40
Construction at All American Marine shipyard	40
Project Costs.....	41
Discussion of One-Time Costs / Cost Reduction Potential for Future Builds.....	42
Ferry Operation	44
Subsegment #1 – At Berth	45
Subsegment #2 – Transit from Alameda Point to San Francisco Ferry Building.....	47
Subsegment #3 – Transit from San Francisco Ferry Building to Alameda Point.....	49
Segment #4 – Entire Voyage.....	51
Ferry Performance	53
Bunkering / Fuel Consumption	54
Sample Hydrogen Bunkering (Feb 8, 2024):	54
Operational Time Stamps:.....	54
Bunkering Log:	54
Duration and Volume:.....	55

Hydrogen Truck Transport:.....	55
Ferry Transit Distance To Hydrogen Bunkering:.....	56
Fueling Process:	56
Infrastructure Reliability:	57
Hydrogen Price:	58
Hydrogen Carbon Content:	60
Total Cost of Ownership:	60
Maintenance	62
Maintenance Repairs / Service Calls.....	63
Safety.....	64
User Experience	65
<i>Lessons Learned – Discussion of Pertinent Issues or Problems</i>	<i>66</i>
Project Team Experience and Shipyard Selection.....	66
COVID Impacts / Commercialization.....	66
Regulatory	67
Operation, Repair, Maintenance / Technology Challenges.....	67
Fueling	68
Why Hydrogen?	68
Energy Intensity / Energy Density	68
Energy Storage, Power, and Scalability	69
Efficiency	69
Established Architectures and Fueling Procedures	70
<i>Discussion of future applications and commercialization prospects</i>	<i>71</i>

List of Acronyms

Abbreviation	Explanation
AAM	All American Marine
ACTM	Alternating Current Traction Motor
atm	Atmospheric Pressure
BAE	BAE Systems
Bay Area Air District	Bay Area Air Quality Management District
BDU	Battery Disconnect Unit
BSY	Bay Ship & Yacht
CARB	California Air Resources Board
cbm	Cubic Meter
CCI	California Climate Investments
CHC	Commercial Harbor Craft
COI	Certificate of Inspection
DI	Deionized
DOE	Department of Energy
ESS	Energy Storage System
FC	Fuel Cell
FCDL	Fuel Cell Data Logger
gal	Gallon
GHG	Greenhouse Gasses
H2	Hydrogen
HAZID	Hazard Identification (Workshop)
HFTO	Hydrogen Fuel Cell Technologies Office
HSS	Hydrogen Storage System
HV	High Voltage
IBank	California Infrastructure Economic Development Bank
IGF Code	International Code of Safety for Ships using Gases or other Low-flashpoint Fuels
K	Kelvin
kg	Kilogram
kts	Knots
kWh	Kilowatt-hour
LHV	Lower Heating Value
LNG	Liquefied Natural Gas
LV	Low Voltage
MMBtu	One million British thermal units
NFPA 2	National Fire Protection Association Hydrogen Technologies Code
NorCal FDC	Northern California Financial Development Corporation
OFE	Owner's Furnished Equipment
PDT	Pacific Daylight Time

PE	Private Equity
PEM	Proton Exchange Membrane Fuel Cell
PIC	Person In Charge
psi	Pounds Per Square Inch
PST	Pacific Standard Time
PSTP	Periodic Safety Test Procedure
PT	Pressure Transducer
SF	San Francisco
SWITCH	SWITCH Maritime - Vessel Owner
TCO	Total Cost of Ownership
TK	Tank
USCG	United States Coast Guard
UTC	Coordinated Universal Time
VC	Venture Capital
WETA	Water Emergency Transportation Authority
XALT	XALT Energy
XMP	XPAND Modular Pack (Battery)
ZEI	Zero Emissions Industries (Previously Golden Gate Zero Emission Marine or GGZEM)

List of Figures

Figure	Explanation
Figure #1	Sea Change Hydrogen Tank Diagram
Figure #2	Sample Sea Change HSS Display
Figure #3	Sample Sea Change FC Display
Figure #4	Sea Change General Arrangement
Figure #5	PEM Fuel Cell Diagram
Figure #6	BAE Electric Propulsion System
Figure #7	Sea Change Project Cost Summary
Figure #8	Sea Change Project Cost Breakdown
Figure #9	Sea Change Costs Over Time
Figure #10	Data Analysis Subsegment #1
Figure #11	Data Analysis Subsegment #2
Figure #12	Data Analysis Subsegment #3
Figure #13	Data Analysis Subsegment #4
Figure #14	Sea Change Speed vs. Power Curve
Figure #15	Sea Change Hydrogen Bunkering Fill Rate
Figure #16	Hydrogen vs. Diesel Price Comparison
Figure #17	Hydrogen vs. Diesel Operational Price Comparison
Figure #18	Total Cost of Ownership, Premium / Discount Relative to Diesel Equivalent
Figure #19	Total Cost of Ownership Components

List of Tables

Table	Explanation
Table #1	Sea Change Laden Performance (Speed vs. Power)
Table #2	Sea Change Sample Bunkering Log
Table #3	Sea Change Planned Maintenance Schedule

Executive Summary

The *Sea Change* project is managed and financed by SWITCH Maritime, a developer of a fleet of zero-carbon maritime vessels for adoption by existing ship owners and operators. It is the first of the larger zero-carbon ferry fleet that SWITCH plans to develop in partnership with municipalities and shipowners aiming to transition to carbon-free vessels, leveraging government grant funds related to transportation decarbonization activities together with private investment.

Constructed at All American Marine shipyard in Bellingham, Washington, the *Sea Change* is a 70-foot catamaran ferry designed by Incat Crowther, equipped with a hydrogen system from Zero Emissions Industries (ZEI), which includes a 360 kW fuel cell system from Cummins, a hydrogen storage system with 246 kg of total capacity from Hexagon Purus, and a 600 kW electric propulsion system from BAE Systems (BAE), which includes 100kWh of lithium-ion battery storage from XALT Energy (XALT). The construction management was led by the Hornblower Group.

The project is also partially funded by a \$3 million grant from the CARB, administered by the Bay Area Air District, that comes from the California Climate Investments (CCI) initiative, a California state-wide program that puts billions of cap-and-trade dollars to work reducing greenhouse gas emissions, strengthening the economy, and improving public health and the environment—particularly in disadvantaged communities.

Additionally, the project received the first ever loan guarantee under Bay Area Air District's Climate Tech Finance program, which seeks to reduce greenhouse gases by accelerating emerging climate technologies. In partnership with the California Infrastructure Economic Development Bank and the Northern California Financial Development Corporation (NorCal FDC), the Climate Tech Finance team led a technology qualification and greenhouse gas analysis that deemed SWITCH eligible for a loan guarantee. This loan guarantee supported SWITCH in securing a \$5 million construction and term loan with KeyBank.

The vessel was operated for three months of sea trials to collect performance data and usage information. This information is included in this report to support CARB in assessing the suitability of hydrogen fuel cell technology in maritime applications and could directly influence new incentives and regulations to further zero emission hydrogen and fuel cell usage on the water to meet the state's clean air goals. The data collection work is led by Sandia National Laboratories as an independent, third-party analyst with expertise in hydrogen fuel cell technology.

Successfully completing the project required navigating many challenges, which provide a host of valuable lessons learned, relevant to the State of CA, the US federal government (both Department of Energy and Department of Transportation), maritime stakeholders with a safety regulatory focus (USCG, Ports, Fire Departments) and commercial industry participants. Leveraging the lessons of the *Sea Change* can maximize the probability of success for future innovative zero-emissions hydrogen fuel cell vessel projects. Some key takeaways include: selecting shipyards with high technical competency, especially pertaining to electrical systems; carefully scoping project budgets and timelines with sufficient contingency to allow ample room for unforeseen events (e.g. global pandemic), regulatory/permitting processes, and new technology commissioning; striving to streamline project participation structures with a single entity responsible for managing all subcontractors; maximizing operations and maintenance capabilities in local geographies; and much more. A full exposition of lessons learned is included [later in this report](#).

The 75-passenger vessel will begin public passenger service in Summer 2024 as part of the Water Emergency Transportation Authority or WETA's San Francisco Bay Ferry system, representing a pioneering milestone as the first hydrogen-powered ship in commercial operation in the US. SWITCH believes that successful introduction of this high-visibility, environmentally friendly ferry will lead to other opportunities to scale the use of low-carbon powertrain technology in the maritime industry.

Project Goals and Objectives

The key goals and objectives of this zero-emissions ferry demonstration project are as follows:

- Translate prior theoretical research (specifically research conducted at Sandia National Labs) to practice, proving the viability of fuel cell powertrains in commercial maritime applications
- Design, construction, and operation of a first-of-kind zero emissions fuel cell electric ferry
- Conduct permitting process with the US Coast Guard (USCG) to certify the vessel design, safe operational procedures, fueling practices, and establish a regulatory framework for future hydrogen-fueled zero-emissions vessels
- Data collection and analysis to produce valuable lessons for the broader maritime industry, in the hopes of demonstrating the value of hydrogen use in maritime, accelerating adoption, and improving technology advancement
- Provide opportunities for outreach and education, supporting the dissemination of information about zero-emissions vessel options to the public and market
- Commercialize the fuel cell electric ferry, creating a proof point for existing operators and supporting their ability to integrate similar vessels into their fleets



Sea Change underway in Bellingham, WA

Project Team



--- SWITCH Maritime ---

Established in 2017, SWITCH Maritime (“SWITCH”) is a US maritime project company developing and commercializing North America’s first fleet of zero emissions maritime vessels. SWITCH believes electrification, using both hydrogen fuel cell as well as battery, has the potential to address “hard-to-decarbonize” high horsepower transportation sectors, including maritime shipping. SWITCH aims to facilitate existing vessel operators’ transition to zero-carbon solutions by offering them capital-efficient access to zero-emissions vessels along with clean fuel supply solutions. More information can be found at <https://www.switchmaritime.com/>.

Project Role: Vessel Owner, Sub-Grantee.



--- Zero Emission Industries ---

Launched 2017, Zero Emission Industries, previously Golden Gate Zero Emission Marine, is a hydrogen technology company that provides critically needed proprietary technology and combines it with fuel cells from leading manufactures to offer OEMs and integrators turn-key, modular and scalable hydrogen power systems for use in their products. Learn more at <https://zeroei.com/>.

Project Role: Hydrogen Systems Engineering & Integration.



--- All American Marine ---

All American Marine Inc., located on the shores of Bellingham Bay, was founded in 1987 and specializes in the construction of custom-tailored aluminium vessels. The company is a leading builder of high-speed passenger boats, hybrid vessels, dinner cruise boats, patrol crafts and research vessels. AAM is a proud member of the Bryton Marine Group. Stay tuned to AllAmericanMarine.com or on [Facebook](#) and [Instagram](#) for all the latest news on what’s next!

Project Role: Vessel Construction.



--- Incat Crowther ---

Incat Crowther is a team of engineers and innovators who provide design, build and consulting services for specialized ships from offices located in the United States, Australia, and the United Kingdom. Incat Crowther has a 30 year history with over 600 vessels in operation. As a Digital Shipbuilder, Incat Crowther has the versatility to propose multiple design and construction solutions leading toward an operator-driven optimum solution. Latest company news is available on social media or at <https://www.incatcrowther.com/>

Project Role: Vessel Design & Engineering.



--- Hornblower Group ---

Hornblower Group is a global leader in world-class experiences. The corporate entity of Hornblower Group is comprised of City Experiences and Seaward Services. City Experiences offers experiential land-based and water-based travel excursions worldwide and is a leader in providing passenger ferry transportation services. Seaward Services, Inc., a marine services company specializing in the operation, maintenance, and repair of government and privately owned commercial working vessels, is also a subsidiary of Hornblower Group, operating and maintaining US Navy Ranges and port facilities, local oil spill response, and offshore wind farms. Today, Hornblower's footprint spans 111 countries and territories, and 125 US cities. Hornblower Group is headquartered in San Francisco, California, with additional corporate offices in Boston, Massachusetts; Chicago, Illinois; London, United Kingdom; New York, New York; and Ontario, Canada.

Notably, Hornblower Group designed and built the first hybrid ferry in the United States which reduces fuel consumption by 75% (Hornblower Hybrid). Hornblower Group also operates the first zero-emission, all-electric passenger/vehicle ferry in the US (Gee's Bend Ferry), managing the design and construction of the first hydrogen fuel-cell passenger ferry in the world (Sea Change), and managing the design, construction, and operation of a growing fleet of hybrid-ready crew transfer vessels for the developing offshore wind farms.

More at: <https://www.hornblowercorp.com/>

Project Role: Construction Management.



--- West Coast Clean Fuels ---

WCCF was established to serve a growing market need for the delivery of future low-carbon maritime fuels, such as LNG (liquefied natural gas), RNG (renewable natural gas), and hydrogen-based fuels (such as hydrogen, methanol, and ammonia). WCCF has designed the initial supply chain based on smaller delivery volumes using truck-to-ship fuel transfers, with the ability to scale as SWITCH's hydrogen-fueled maritime fleet expands.

More at: <https://www.westcoastcleanfuels.com/>

Project Role: Hydrogen Fuel Supply Chain Permitting & Management.



--- Cummins / Accelera ---

In March of 2023 Cummins Inc. introduced Accelera™, marking a strategic evolution within its New Power business segment towards zero-emission technologies. As part of Cummin's Destination Zero initiative aimed at achieving zero emissions across its product suite, the company has invested significantly, exceeding \$1.5 billion in research, development, and strategic acquisitions. Accelera stands at the forefront of Cummin's efforts to offer sustainable solutions, leveraging over 70 years of combined zero emissions. To date, vehicles equipped with Accelera's eMobility products have surpassed 1.5 billion miles driven, underscoring the practical impact and reliability of its electric vehicle technologies. Additionally, Accelera has made substantial contributions to the hydrogen economy, with more than 600 electrolyzers and over

3,000 fuel cells deployed globally. Acceler's extensive distribution network spans 190 countries, demonstrating the bran's global reach and commitment to facilitating a worldwide transition to sustainable energy solutions.

More at: <https://www.accelerazero.com/>

Project Role: Hydrogen Fuel Cell Power Package Provider.



--- BAE Systems ---

BAE Systems has been on the forefront of clean power and propulsion with a market-leading electric drive system. For more than 25 years, we have been helping fleet operations get to zero emissions with hybrid electric, battery electric and fuel cell electric solutions. Today, our more than 16,000 systems are making an impact on the environment. BAE Systems, electrification simplified. More at www.baesystems.com

Project Role: Electric Propulsion Provider & Integrator.



--- Hexagon Purus ---

Hexagon Purus is a world leading provider of hydrogen type 4 high-pressure cylinders, battery packs and vehicle systems integration for fuel cell electric and battery electric vehicles. Hexagon Purus enables zero emission solutions for light, medium and heavy-duty vehicles, buses, ground storage, distribution, maritime, rail and aerospace. Learn more at <https://hexagonpurus.com/>

Project Role: Hydrogen Storage Tank Provider.



--- CARB California Climate Investments ---

Funding for the CARB grant for the country's first zero-emission ferry comes from California Climate Investments, a statewide program that puts billions of Cap-and-Trade dollars to work reducing greenhouse gas emissions, strengthening the economy and improving public health and the environment — particularly in disadvantaged communities. Further information is available at <https://ww2.arb.ca.gov/homepage>

Project Role: Grantor.



--- Bay Area Air Quality Management District ---

The [Bay Area Air Quality Management District](#) is the regional agency responsible for protecting air quality in the nine-county Bay Area. Connect with the Air District via [Twitter/X](#), [Facebook](#), and [YouTube](#).

Project Role: Grant Administration and Climate Tech Finance program.



--- Sandia National Laboratories ---

For more than 70 years, Sandia has delivered essential science and technology to resolve the nation's most challenging security issues. Sandia National Laboratories is operated and managed by National Technology and Engineering Solutions of Sandia, LLC., a wholly owned subsidiary of Honeywell International, Inc. National Technology and Engineering Solutions of Sandia operates Sandia National

Laboratories as a contractor for the US Department of Energy's National Nuclear Security Administration (NNSA) and supports numerous federal, state, and local government agencies, companies, and organizations. A strong science, technology, and engineering foundation enables Sandia's mission through a combination of innovation, collaborative research with universities and companies, and discretionary research projects with significant potential impact. Sandia's Hydrogen Program is based at its Livermore CA facility, and has for the past 60+ years conducted R&D to advance hydrogen technology, including hydrogen storage, production, the safety codes and standards governing its use, and exploring the feasibility of using hydrogen fuel cells in various end-use applications, including ships. The Sandia Hydrogen Maritime Fuel Cell Market Transformation activity was initiated in 2014 and continues to this day.

More at: <https://www.sandia.gov/>

Project Role: Data Analysis



--- KeyBank ---

Key Equipment Finance, a division of KeyBank, has been in the equipment, software and services finance business for over 50 years and is one of the largest bank-owned equipment finance providers in the US. The company provides tailored equipment lease and finance solutions for commercial clients and government entities, manufacturers, distributors, resellers and, through Specialty Finance Lending, a business unit of KeyBank, provides structured facilities across various sectors of the specialty finance market. Additionally, Key Equipment Finance's capital markets team utilizes its syndication capabilities to structure large, multi-bank transactions. With headquarters outside Denver, Colorado, Key Equipment Finance manages approximately \$14.9 billion in assets and originates approximately \$5.5 billion of equipment financing annually. For more information, visit keyequipmentfinance.com.

Project Role: Vessel Lender.

Vessel Design

Vessel design was led by naval architect Incat Crowther and informed by [prior feasibility studies conducted at Sandia National Labs](#) as well as decisions to maximize vessel safety characteristics, guided by collaboration with the USCG.



Sea Change - 3D Engineering Rendering

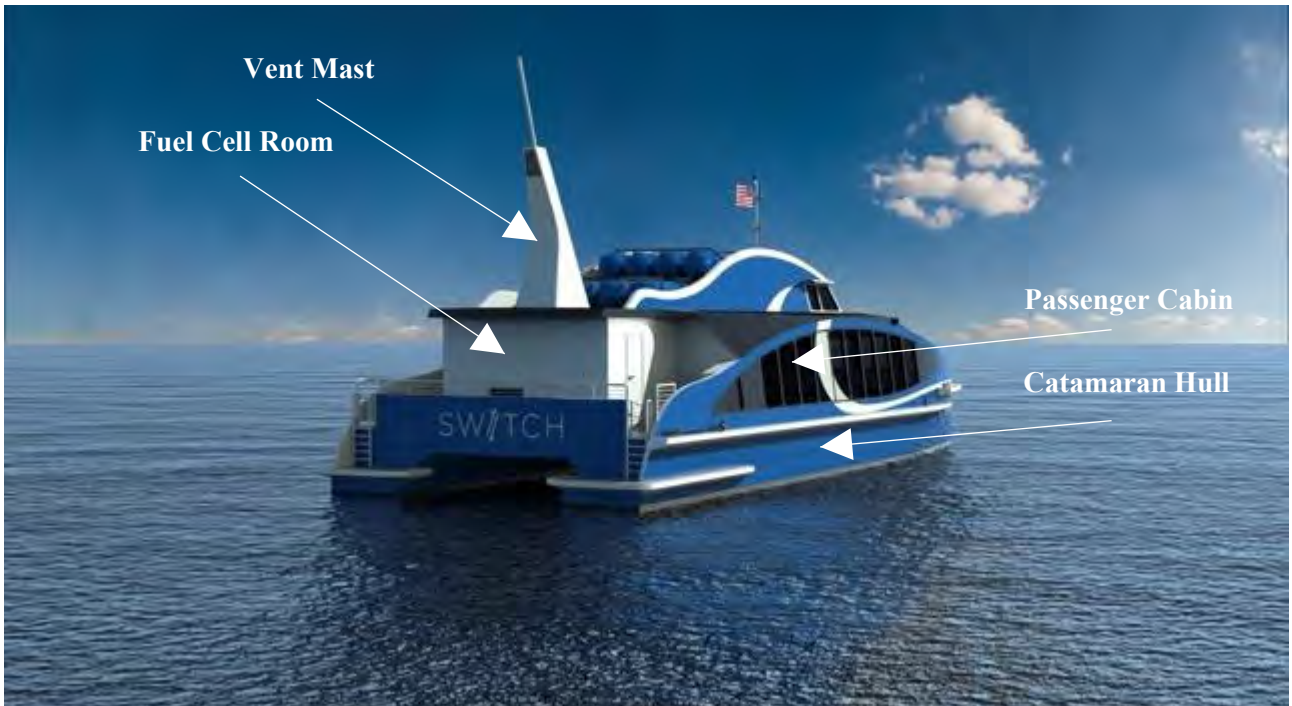

Sea Change - 3D Engineering Rendering



Sea Change - 3D Engineering Rendering

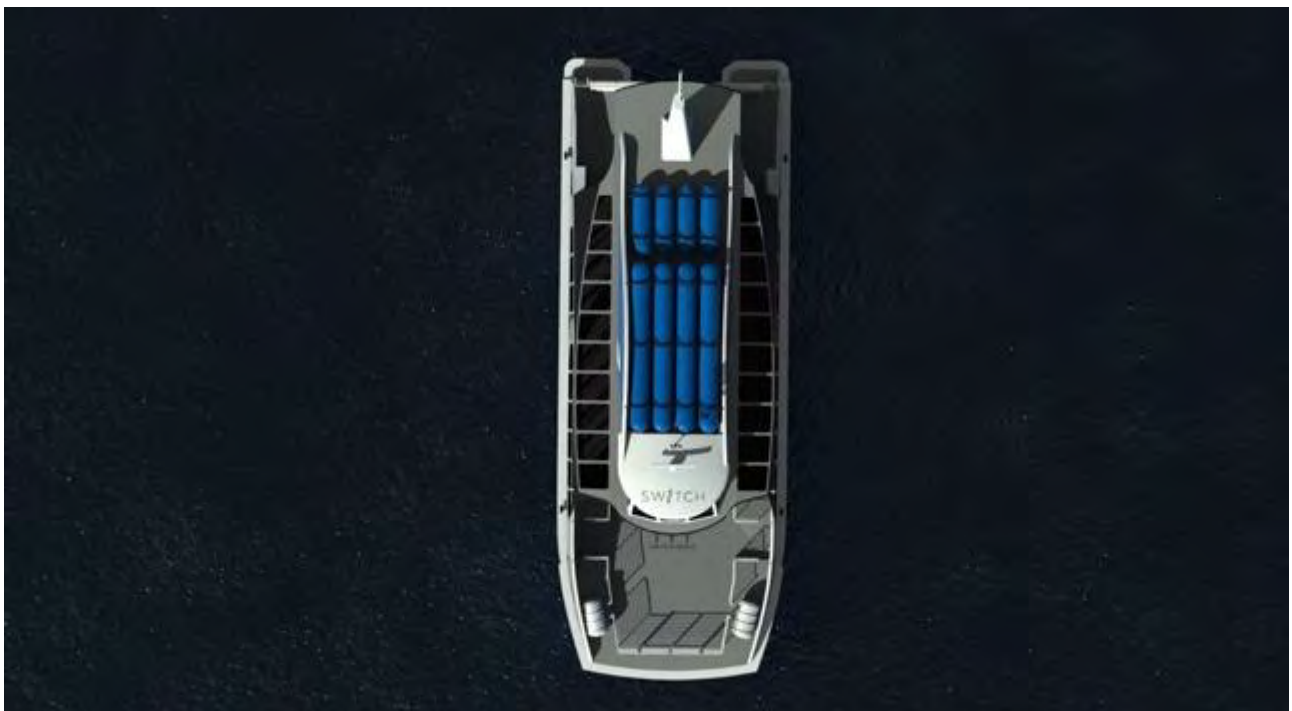

Sea Change - 3D Engineering Rendering

Certain key safety-oriented design decisions for the Sea Change include: (1) locating hydrogen tanks on open top deck, (2) creating a full A-60 fire boundary (designed to protect people from fires for up to 60 minutes) between the passenger cabin and hydrogen, (2) locating fuel cells in an emergency shutdown (ESD)-protected space, (3) hydrogen, smoke, and fire detection systems throughout the vessel with automated shutdowns if triggered, and (4) classified electronic equipment in hazardous zone areas. The Sea Change design has established an important baseline for safety, from which future iterations of zero-emissions hydrogen fuel cell vessels can build and evolve.

Outreach and Education

The SWITCH team and project partners have dedicated significant time over the course of *Sea Change* development to spreading awareness about hydrogen fuel cell and battery electric propulsion technologies in service of raising awareness about maritime decarbonization while educating the general public and industry participants.

Cal Maritime Student Tour:



CBS Coverage:



Forbes Coverage:

An E-Ferry For A Morning Commute? Of Course It's In San Francisco

F forbes.com/sites/juliewalmsley/2019/06/27/an-e-ferry-for-a-morning-commute-of-course-its-in-san-francisco/

Julie Walmsley

June 27, 2019



Reuters Coverage:

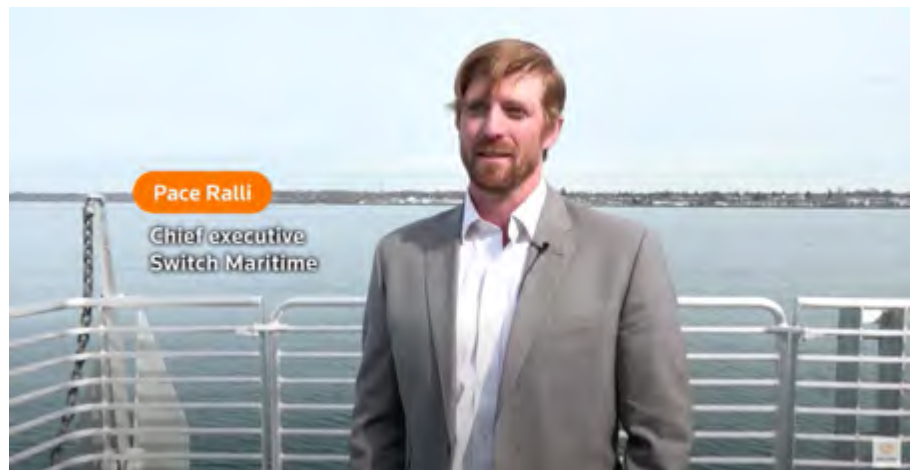

**Maritime Hybrid,
Electric & Hydrogen Fuel
Cells Conference (2023 in
Bergen, Norway):**



Elias Van Sickle (SWITCH Maritime, bottom right) presents the Sea Change project as a zero emissions vessel case study to industry participants

**San Francisco Chronicle
Coverage:**

Sign In
San Francisco Chronicle

First zero-emissions fuel cell ferry in the U.S. arrives in San Francisco

California hopes the ferry demonstrates how the shipping industry can move away from fossil fuels with hydrogen fuel cell technology.

By **Tara Duggan**
Updated March 24, 2023 7:12 p.m.

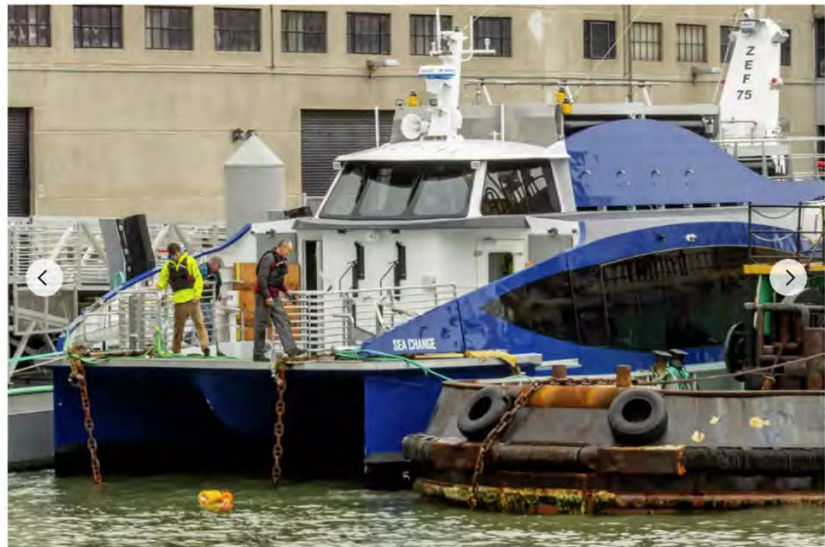

Crews secure the Sea Change after it was towed to Pier 9 in San Francisco on Sunday. After many delays during the pandemic, the first hydrogen fuel-cell powered ferry is set to debut on the San Francisco waterfront.
Carlos Avila Gonzalez/The Chronicle

Verify Pressure Measurements (Manual Gauges to HSS Readings): Alignment between HSS pressure indicators and manual pressure gauges on the top deck of the Sea Change was successfully verified (confirmed satisfactory).

Comparing HSS pressure system display with manual gauges:

- Manual Gauge Reading PT003 = 96 psi
- HSS System Display for PT003 = 93 psi.
- % difference = 3.1%

- Manual Gauge Reading for PT100 = 2400 psi
- HSS System Display for PT100 = 2586 psi.
- % difference = 0.7%

- Manual Gauge Reading for PT200 = 2400 psi
- HSS System Display for PT200 = 2446 psi
- % difference = 1.9%

- Manual Gauge Reading for PT300 = 2450 psi
- HSS System Display for PT 300 = 2536 psi.
- % difference = 3.4%.

This test shows that the HSS system pressures (which report pressure transducer readings), are in agreement with visual checks of manual gauges to within 3.4%, which indicates satisfactory agreement.

Verify Pressure Measurements (HSS to Data Logger): Alignment between the Data Logger and HSS System Display was successfully verified (confirmed satisfactory).

At the same measurement time:

- HSS Report of PT100 Pressure = 2648 psi
- Data Logger PT100 Pressure = 2586 psi.
- % difference = 0.3%

- HSS Report of PT200 Pressure = 2502 psi
- Data Logger PT200 Pressure = 2502 psi
- % difference = 0.0%

- HSS Report of PT300 Pressure = 2559 psi
- Data Logger PT300 Pressure = 2556 psi.
- % difference = 0.1%.

This test shows that the HSS system pressures (which report pressure transducer readings), are in agreement with the Data Logger record to within 0.3% in pressure. This provides confidence the measurement of hydrogen pressures on the vessel are handled well and are being logged by the Data Logger correctly.

**Hydrogen and Fuel Cell
Technology, Safety, and
Marine Regulations
course at USCG Sector
San Francisco, March 12,
2024:**



Hosted by Lennie Klebanoff (Sandia National Labs) and Joe Pratt (Zero Emissions Industries)

America's first hydrogen-powered ferry is set to sail

Switch Maritime aims to start operations early next year in San Francisco. It just raised \$10M to help take zero-emissions ferries nationwide.



By Maria Gallucci
16 November 2023



The Sea Change hydrogen ferry (Switch Maritime)

High Ambition Climate Collective – Vessel Tour:



Methodology

This methodology section outlines the steps taken during the analysis process to (1) verify the accuracy of the automated data being collected and (2) arrive at key metrics such as hydrogen consumption and fuel cell efficiencies. Detailed analyses and full calculations of key metrics are contained in the [Ferry Operation](#) section below.



*Sea Change at Berth in
Alameda Island CA.*



*Lennie Klebanoff
(Sandia National Labs)*



*Joe Pratt and Yazan Arafat
(Zero Emissions Industries)*



*Elias Van Sickle (SWITCH Maritime)
and Megan Torres (USCG)*

Verification of Time Basis:

The hydrogen storage system (HSS) captures data for the pressure and temperature of the hydrogen tanks. The Fuel Cell Data Logger (FCDL) records fuel cell output power and status. The objective of this initial assessment is to understand the time relationships of these databases to sync up analyses using both data sets. The HSS system time was found to agree with Pacific Daylight Time (PDT). A small discrepancy was found between the time base of the FCDL and the HSS. Specifically, the FCDL lags the HSS time by 3 minutes and 31 seconds. This discrepancy is accounted for and corrected in the data analysis.

Tank Pressure Measurements:

The first important input for the data analysis is hydrogen tank pressures, which are measured on the *Sea Change* via two primary pressure transducers (PT200 and PT300):

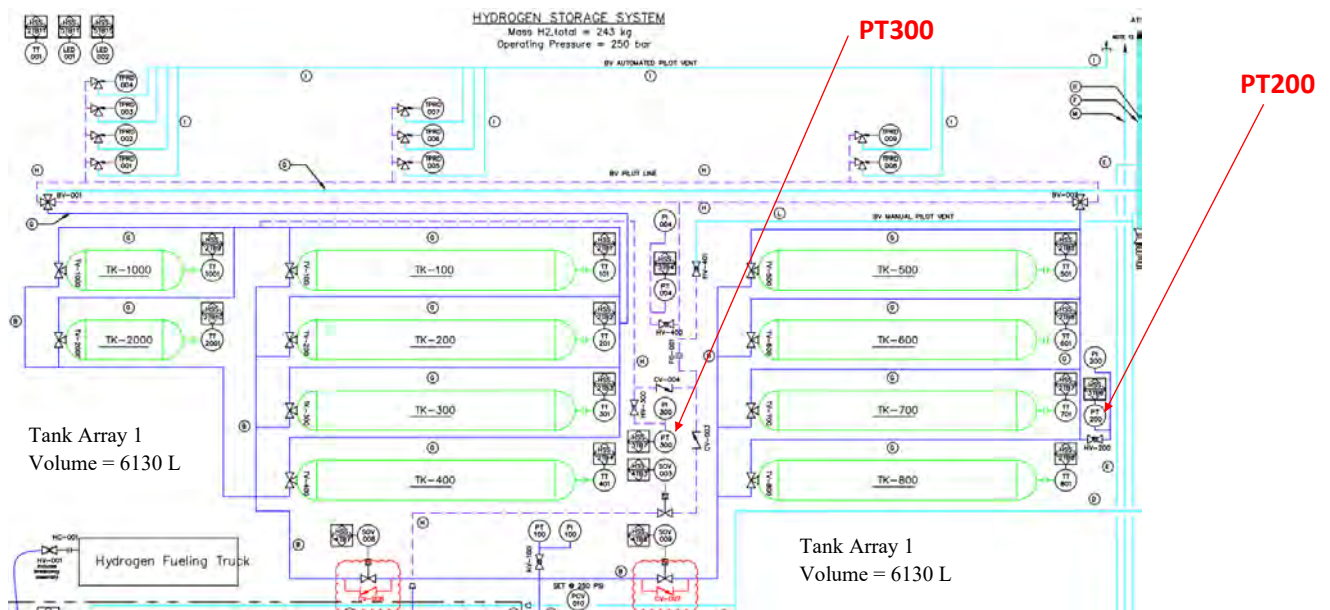

Figure #1 - Sea Change Hydrogen Tank Diagram

PT200 measures the 4 large tanks on the upper row of the array (TK-500, 600, 700, and 800) with total volume = $4 \times 1532.5 \text{ L} = 6130.0 \text{ L}$. PT300 measures the 4 large tanks on the lower row of the array (TK-100, 200, 300, 400) and the 2 small tanks (TK-1000, 2000) with total volume = $4 \times 1532.5 + 2 \times 576 = 7282 \text{ L}$.

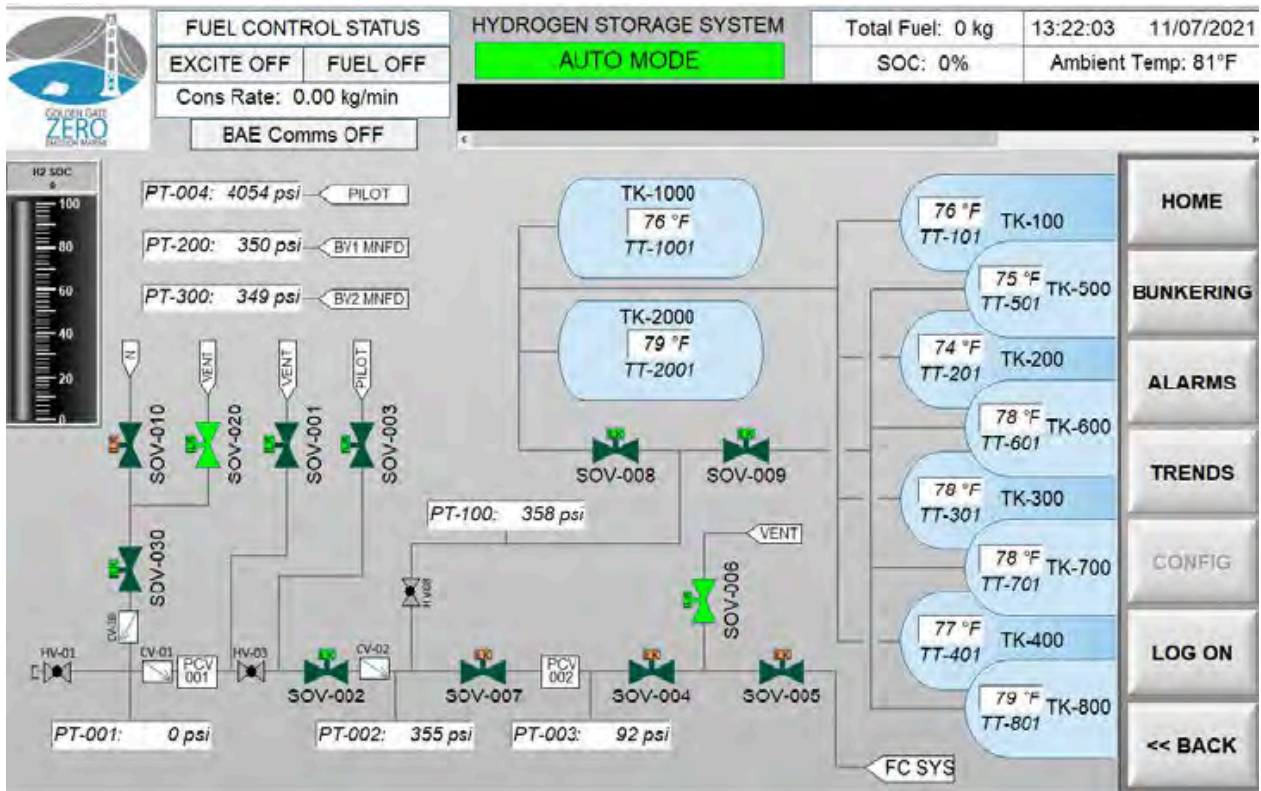

Figure #2 - Sample Sea Change HSS Display

Verify Pressure Measurements (Manual Gauges to HSS Readings): Alignment between HSS pressure indicators and manual pressure gauges on the top deck of the Sea Change was successfully verified (confirmed satisfactory).

Comparing HSS pressure system display with manual gauges:

- Manual Gauge Reading PT003 = 96 psi
- HSS System Display for PT003 = 93 psi.
- % difference = 3.1%

- Manual Gauge Reading for PT100 = 2400 psi
- HSS System Display for PT100 = 2586 psi.
- % difference = 0.7%

- Manual Gauge Reading for PT200 = 2400 psi
- HSS System Display for PT200 = 2446 psi
- % difference = 1.9%

- Manual Gauge Reading for PT300 = 2450 psi
- HSS System Display for PT 300 = 2536 psi.
- % difference = 3.4%.

This test shows that the HSS system pressures (which report pressure transducer readings), are in agreement with visual checks of manual gauges to within 3.4%, which indicates satisfactory agreement.

Verify Pressure Measurements (HSS to Data Logger): Alignment between the Data Logger and HSS System Display was successfully verified (confirmed satisfactory).

At the same measurement time:

- HSS Report of PT100 Pressure = 2648 psi
- Data Logger PT100 Pressure = 2586 psi.
- % difference = 0.3%

- HSS Report of PT200 Pressure = 2502 psi
- Data Logger PT200 Pressure = 2502 psi
- % difference = 0.0%

- HSS Report of PT300 Pressure = 2559 psi
- Data Logger PT300 Pressure = 2556 psi.
- % difference = 0.1%.

This test shows that the HSS system pressures (which report pressure transducer readings), are in agreement with the Data Logger record to within 0.3% in pressure. This provides confidence the measurement of hydrogen pressures on the vessel are handled well and are being logged by the Data Logger correctly.

Fuel Cell Power Measurements:

The second important input for data analysis is fuel cell power output and state (e.g. Standby, Running, Comm Loss, etc). This information is automatically captured and logged by the FC DL.

The sample screenshot below shows two of the three fuel cell racks running with FC Rack 1 producing 45.01 kW and FC Rack 2 producing 30.42 kW of power, for a combined power output of 75.43 kW. When any fuel cell rack is manually turned off, its state will show a “Comm Lost” (see FC Rack 3) and a power output of 0 kW.

During normal operations, all three fuel cell racks are running; however, it’s important to state that each rack is considered a redundant source of power. If one fuel cell rack were to experience an issue, the other two would continue to run.



Figure #3 - Sample Sea Change FC Display

Using both hydrogen pressures along with fuel cells as inputs, both energy consumption and fuel cell efficiency can be calculated. More specifically, the total electrical energy output of the fuel cell divided by the total hydrogen energy consumption during the same time period would yield the efficiency of the fuel cell (E.g. $764.1 \text{ kWh} / 1670.5 \text{ kWh} = 0.457 = 45.7\%$).

Ferry Specification

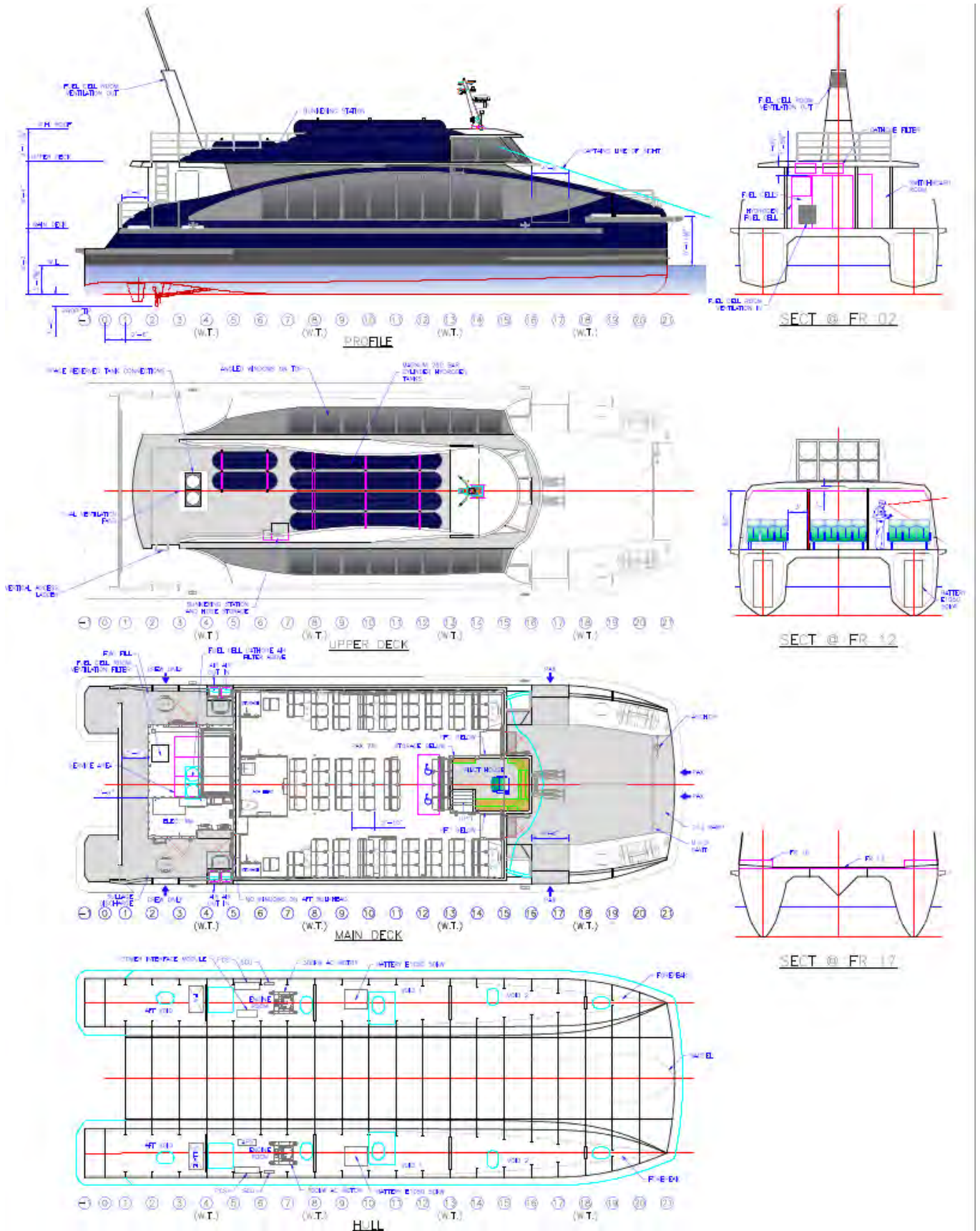

Figure #4 - Sea General Arrangement

Vessel Type	Catamaran Passenger Vessel
Material	Marine Grade Aluminum
Length Overall (LOA)	72'-7"
Beam	24'-6"
Passenger Capacity	78
Crew Capacity	2-3
Tank Capacity (Hydrogen)	246 kg at 250 bar
Regulatory Authority	US Coast Guard Subchapter T
Main Propulsion	2 x 300 kW AC Traction Motors (BAE Systems ACTM-300)
Fuel Cells	3x HyPM-R HD 120kW Racks
Batteries	2x XALT 50 kWh packs
Hydrogen Tanks	8x Hexagon Magnum 26" x 225" + 2x Hexagon Magnum 26" x 95". Type IV tanks: interior polymer liner in contact with hydrogen, carbon composite overwrapped pressure vessel.
Propulsion	5 Blade Fixed Pitch Propeller

Hydrogen Storage

The ferry's bunker panel is designed to be able to accept compressed hydrogen gas from existing hydrogen transport trailers, with a hose reel that extends from the ferry's top deck and connects to a hydrogen transport trailer on land for a truck-to-ship transfer. Gas dispensed from the truck flows into ten (10) Type IV composite storage tanks that are located on the top deck of the ferry and hold 246 kgs of hydrogen at a pressure of 3,600 psi or 250 bar. 250 bar storage was selected because it is the lowest cost storage method per kilogram of hydrogen stored. Greater compression at 350 bar or 700 bar would result in greater energy stored per unit volume, but was not elected at the time of initial design due to additional cost.

Large Tanks (8):

- Max operating pressure = 250 bar
- Water Volume (an average of min (1520L and max 1545L) = 1532.5 L
- Stored H₂ capacity (28 kg) listed (likely nominal), 26.67 calculated by Abel-Nobel Equation at Room Temp.

Small Tanks (2):

- Max operating pressure = 250 bar
- Water Volume (an average of min 571L and max 581L) = 576 L
- Stored H₂ capacity (11 kg) listed (likely nominal), 10.0 calculated by Abel-Nobel Equation at Room Temp.

Normally, hydrogen is drawn from all tanks at once when the fuel cells are powered on, and the Sea Change is underway.



Hydrogen Fueling From H2 Transport Trailer

Fuel Cells

Next, the hydrogen from the storage tanks flows through a pressure control valve (PCV), which steps down the pressure from the rated storage pressure of the hydrogen tanks (up to 3600 psi) to the much lower rated pressure required by the fuel cells of 100 psi. The low-pressure hydrogen enters the 360-kW fuel cell system, where electricity is produced to power electric motors with zero exhaust smoke or other emissions and very little vibration and noise.

A number of “hydrogen conversion” technologies are available for power production / propulsion. Further analysis of these options is addressed in other literature, such as Chapter 2 of *Hydrogen Storage Technology Materials and Applications* by Lennie Klebanoff. A Proton Exchange Membrane or PEM fuel cell is one such technology that is best suited for maritime applications because it provides zero emissions of greenhouse gases (GHGs) or criteria pollutants at the point of use, rapid response, high thermal efficiency converting hydrogen fuel energy, and a compact physical footprint.

A hydrogen fuel cell functions based on an electrochemical reaction without direct combustion, that creates useful electrical output. As demonstrated in the diagram below, a PEM fuel cell requires input of hydrogen and oxygen gasses, which react when they come in contact with a catalyst. At the PEM anode (site of oxidation) hydrogen gas ionizes (oxidizes), releasing protons and electrons to the external circuit. At the cathode (site of reduction), oxygen molecules are reduced in an acidic environment by electrons from the circuit, forming water molecules. Protons pass through the proton exchange membrane, from anode to cathode, completing the circuit.

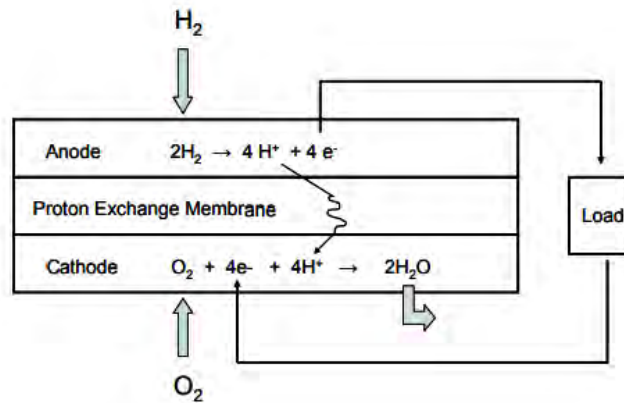

Figure #5-- PEM Fuel Cell Diagram¹

Although multiple types of fuel cells exist, PEM fuel cells were elected because they combine all the advantages of being commercially available, having a strong track record, having fast turn on times, and having the smallest weight and volume for the delivered power.

In the fuel-cell power “racks” used in the Sea Change, individual fuel-cell power modules of nominal power ~30 kW are integrated together into stacks of four (4) individual fuel cell modules for a combined power of 120 kW per rack. Each rack integrates together the H₂ and air supply lines, the liquid coolant lines to remove waste heat, water discharge lines for the wastewater, the exhaust gases from the anode and cathode spaces within the fuel cells, as well as hydrogen detectors and ventilation systems for safety. The operation of each fuel cell power rack is monitored by the control system. For maintenance purposes, the individual fuel cell modules within each rack are easily removed and replaced.

Hydrogenics (now a Cummins company) is a leading supplier of PEM fuel cell systems for both mobile and stationary power applications. Since 2006, Hydrogenics has allocated significant time and resources to working with certification organizations such as UL Solutions to review their products for mobile and stationary power applications. As a result of this process, The HyPM-R 120S Rack complies with the American National Standard/CSA America Standard for Stationary Fuel Cell Power Systems, ANSI/CSA America FC 1-2004. Note that the ANSI/CSA America FC 1-2004 regulation covers operation/service, installation, material compatibility and components to ensure the rack can be safely operated.

The HyPM-R 120S rack also complies with the International Electrotechnical Commission (IEC) 60079-10-1 code of 2015, which refers to the classification of areas where flammable gas or vapor hazards may arise. It provides guidance for classifying the areas on the basis of chemical properties, process installation and process conditions. The IEC 60079-10-1 code is used to determine the ventilation and classification of the rack and surrounding environment to ensure safe operation and installation. When the rack is installed with other components (balance of plant), this standard is used for classification of components of the overall system (rack + balance of plant) for stationary power applications. The HyPM-R 120S rack served as the basis for the hydrogen vessel feasibility studies for the SF-BREEZE high speed ferry and the Zero V research vessel.

The diagram below shows the rack layout, showing locations of individual fuel cell power modules as well as inlets and outlets for fuel cell cooling water, rack ventilation, hydrogen (anode) and air (cathode) inputs and other utilities.

¹ Reproduced with permission from “Comparison of the greenhouse gas and criteria pollutant emissions from the SF-BREEZE high-speed fuel-cell ferry with a diesel ferry”

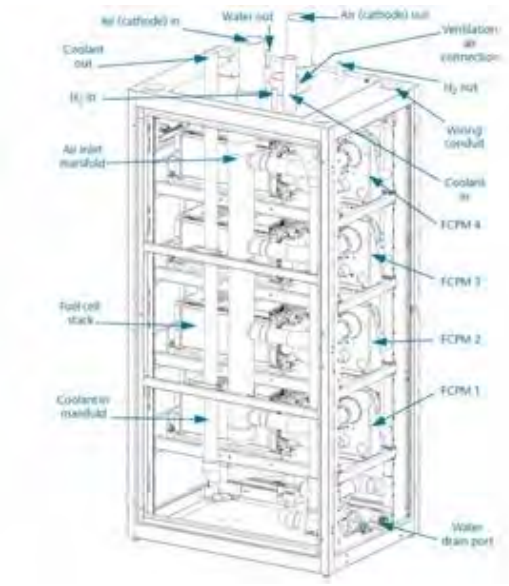

Hydrogen Fuel Cell Rack Diagram



Hydrogen Fuel Cell Rack Dimensions



Individual Hydrogen Fuel Cell Module, courtesy of Cummins / Accelera



Hydrogen Fuel Cell Rack Assembly

Batteries

When the vessel is idling or traveling at low speeds, excess energy can be generated by the fuel cells. This excess electricity is stored in the 100-kWh lithium-ion battery storage system supplied by XALT Energy (XALT). When the vessel needs to travel at high speeds up to 20 knots, the energy stored in the batteries is then used to boost the output from the fuel cells, enabling the electric propulsion system to generate more power.

The XPAND Modular Pack (XMP) is XALT Energy's state-of-the-art Energy Storage System (ESS) based on XALT Energy's world-class lithium-ion cells. XMP is designed for use in commercial truck, bus, and heavy-duty transportation, as well as marine and stationary applications. Similar to the fuel cells, the batteries are housed in 2x 50kWh racks, one situated in each of the two hulls of the catamaran ferry. Each rack is comprised of smaller individual 7 x 7.1 kWh cells, which are scalable when connected together.

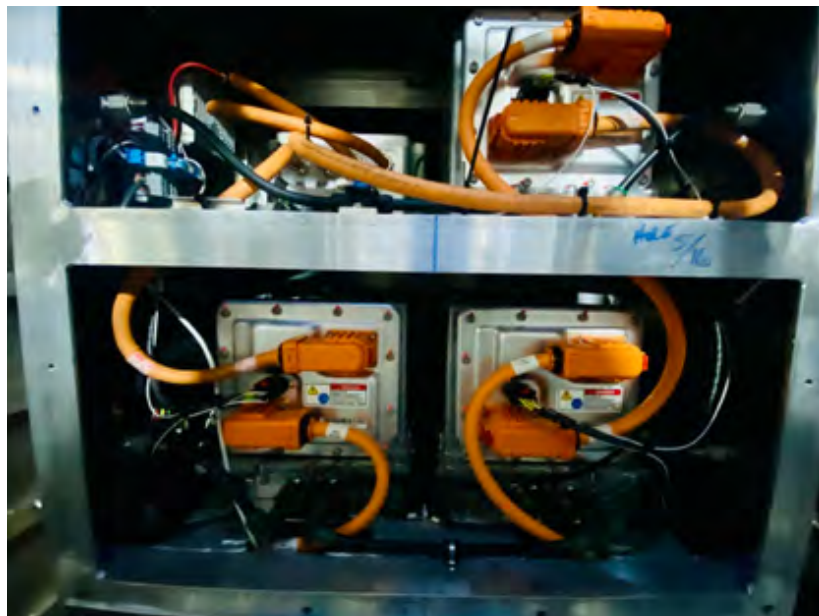

XALT Energy— Battery Rack on Sea Change

Electric Propulsion System

The electric propulsion system is comprised of 2x 300 kW electric AC Traction Motors and various control units, provided by BAE Systems. Electricity that flows out of the fuel cells is efficiently delivered to power the hotel loads, the energy storage system, or paralleling with other power sources for greater power demand and system flexibility.

BAE Systems provided its HybriGen® Power and Propulsion solution to SWITCH for integration on the *Sea Change* vessel. BAE Systems' propulsion system interfaces with a hydrogen and fuel cell system as well as the lithium-ion batteries to power the vessel without the need for a traditional combustion engine. The all-electric system eliminates diesel internal combustion engine use and reduces maintenance to create a clean mode of transportation. The result is a clean, quiet ride for passengers onboard, lower maintenance for operators due to fewer moving components, and no emissions or particulate matter polluting the environment.

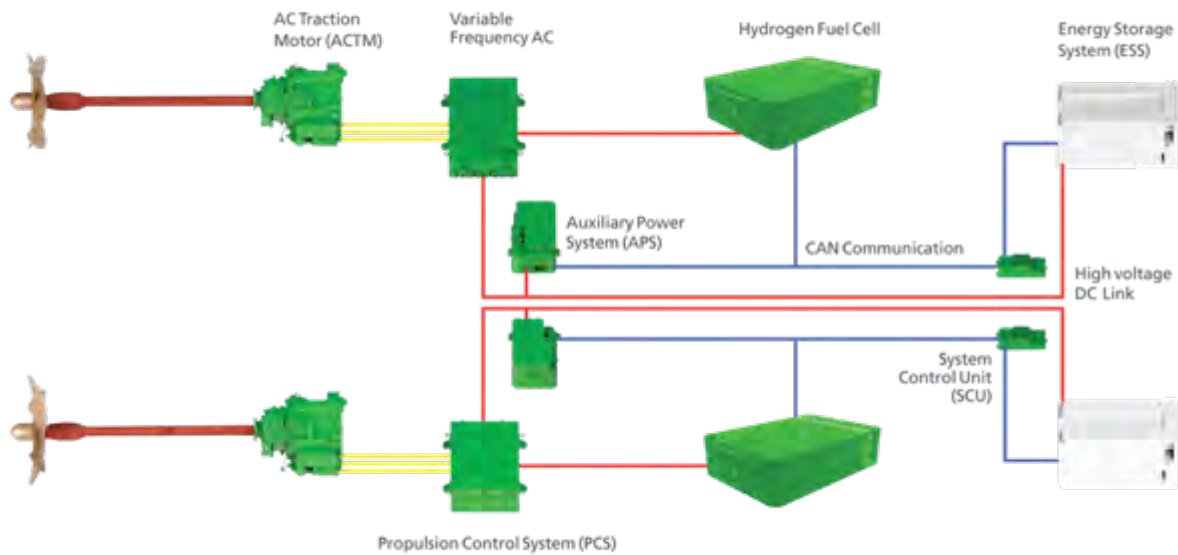
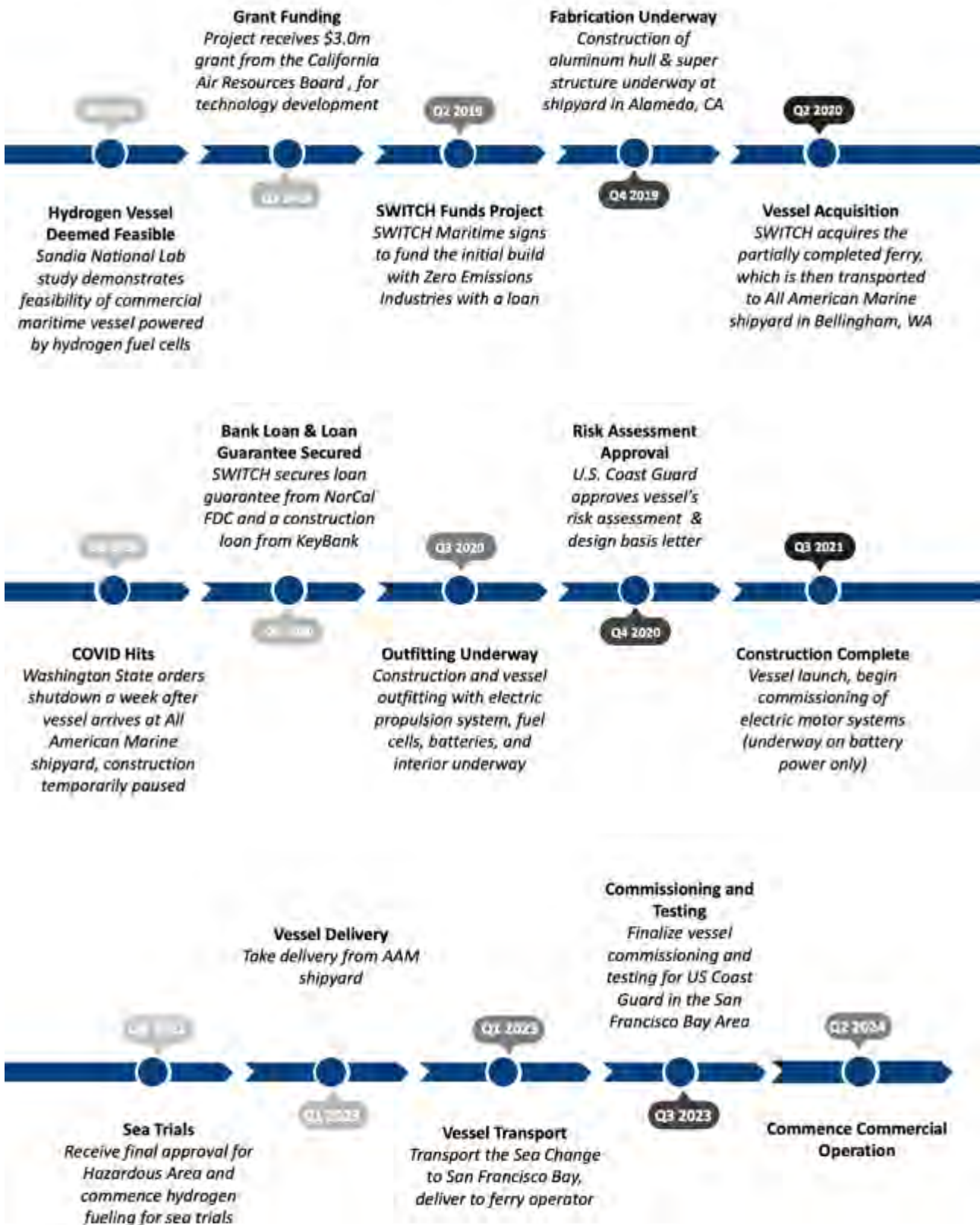

Figure #6 - BAE Electric Propulsion System

Project Schedule and Costs

The design, construction, and commissioning of the *Sea Change* project has taken over 5 years, and can be summarized by the timeline depicted below:



In order to comprehensively understand the full schedule and costs of the *Sea Change* project, it is helpful to review the details of how the project evolved since its inception:

Pre-SWITCH Involvement

In 2016, a study at Sandia National Labs concluded that using fuel cells to power an electric ferry was both technologically and economically feasible. Golden Gate Zero Emission Marine (GGZEM) (now Zero Emissions Industries or ZEI) was founded by Joe Pratt from Sandia National Labs to translate theory into practice, and GGZEM subsequently applied for and secured the original \$3 million project grant from CARB, administered by the Bay Area Air District.

SWITCH Purchase Agreement & Loan to GGZEM to Construction Vessel

In 2018, SWITCH started discussions with GGZEM to partner and fund the project to completion alongside the grant funds, which had thus far been primarily allocated to technology development, design, engineering, and procurement of equipment as owner's furnished equipment or OFE (e.g. fuel cells, storage tanks, batteries, etc). As part of the original structure, GGZEM was committed to working with Bay Ship & Yacht (BSY) in Alameda, CA to build the Incat Crowther design.

By May 2019, SWITCH had solidified its investment case and executed a Purchase Agreement with GGZEM, in order for SWITCH to loan funds to GGZEM to pay its shipyard contract (which it had signed with BSY in April 2019), and other permitting/completion costs through vessel completion. The intention of this structure was for GGZEM to retain ownership of the vessel and act as the primary project lead through to completion and regulatory approval (obtaining certificate of inspection or COI from the USCG), at which time SWITCH would forgive the promissory note and assume ownership of the vessel.

As the source of project construction funds, SWITCH had complete oversight and transparency into the use of all loan proceeds, and would only allow for GGZEM to draw from the loan upon approval of shipyard milestone completion and satisfactory progress.

Amended SWITCH Purchase Agreement & Transfer of Vessel Ownership

Ultimately, the original path to completion that was set forth in the Purchase Agreement did not materialize. By August 2021 (after ~16 weeks of construction), SWITCH became increasingly aware of, and concerned with, schedule changes and shipyard design/cost change orders, and lost confidence in the project management's ability to see the project through with the construction manager utilized by GGZEM. SWITCH brought its own construction management team to assess the growing problems and find a way to course correct the stalled project before it was terminated. Specifically, it became clear that GGZEM and BSY did not agree on the scope and responsibility for production-level engineering drawings that were described in the contract documents and required by BSY in order to build the vessel and achieve the next milestones. BSY was submitting more change orders related to costs it attributed to GGZEM design changes, and trying to amend the delivery schedule based on GGZEM delays. Neither side was progressing and SWITCH therefore stopped loan drawdowns until a path forward was determined.

Due to the inability for existing project managers to find a workable solution with BSY, and SWITCH's concern about the shipyard's technical capabilities to complete such a complex project, SWITCH negotiated with BSY to remove the partially-constructed hull out of the shipyard and cancel the original construction agreement.

At this juncture, SWITCH took ownership of the entire project in exchange for forgiving the loan funds already drawn by GGZEM. On March 5th, 2020, SWITCH and GGZEM executed an Amended Purchase Agreement to reflect the full transfer of ownership before the successful delivery of the vessel, and GGZEM

became the hydrogen technology sub-contractor to the project, providing the integration of the hydrogen powertrain system.

Simultaneously on March 5th, 2020, SWITCH executed a contract cancellation with BSY and made a final make-whole payment for the last completed milestones unpaid by the previous owner. The hull was loaded on to a barge, and a new Vessel Completion Contract (based on time & materials) was executed with All American Marine (AAM), located in Bellingham, WA. Payments were made for shipyard deposit and hull transport, and the vessel was transported to Bellingham, only days before the entire State of Washington shutdown for COVID in mid-March 2020. After a temporary pandemic-related shutdown, AAM was able to restart work on the vessel. The CARB grant was then amended so SWITCH could assume the role of the sub-grantee in place of GGZEM. In so doing, SWITCH signed on to fulfilling the obligation to complete the outstanding grant milestones/tasks in order to receive the remainder of the grant disbursements funds, with the joint goal of restarting the project and carrying it through completion.

The GGZEM project was originally referred to as the ‘Water-Go-Round’ while the project was first under construction at BSY. SWITCH officially named the vessel *Sea Change* during its completion at All American Marine shipyard, and ‘Water-Go-Round’ was no longer used to refer to the project. As the vessel owner, SWITCH was overseeing all aspects of the project, ranging from construction management and financing to commissioning/operation and regulatory processes. At this time, SWITCH also executed a construction management with Hornblower Group to provide construction and permitting management, due to their extensive experience building passenger vessels and knowledge of electric propulsion systems.

Separately, SWITCH had signed a Bareboat Lease agreement with a private operator in San Francisco to operate the completed *Sea Change* upon delivery in the SF Bay, for a corporate client that was looking to launch an employee ferry service in the year leading up to the start of the pandemic. The commercialization of the ferry enabled SWITCH to secure the additional funds from SWITCH’s existing equity provider, and subsequently close a construction and term loan with Key Bank in June 2020 (with a ClimateTech Finance loan guarantee administered by Bay Area Air District and NorCalFDC and California Infrastructure Bank), to complete construction at AAM and launch vessel into commercial operation with lease revenue.

Due to the prolonged nature of the COVID pandemic and its negative impacts on the passenger ferry industry (e.g. work from home policies made permanent), it became clear over time that this first commercialization opportunity for the corporate client would not ultimately come to fruition. This caused SWITCH to have to work to find new employment for the vessel.

Recontracting

As will be discussed further in the [Project Schedule and Costs](#) section below, the cost for projects such as the *Sea Change* are rarely fully covered by grants (e.g. this \$3.0m CARB grant only covered ~20% of the total/final completion cost), therefore the completion of this project relied heavily on SWITCH’s ability to secure private financing in the form of vessel equity and debt, in a very difficult financing environment. This one issue alone plagued the entirety of the project from beginning to end, and is one of the reasons for delay in completion. Not only are there many known and unknown technology, construction, and execution risks inherent in building a ‘first of its kind’ asset, which keep many capital providers on the side lines (especially in the middle of a pandemic when public transportation companies were considered distressed and high-risk investments), but the size and nature of the project meant that it fell squarely in a gap between Venture Capital investors (i.e. VC investors are comfortable with the higher technological risk but maritime assets are too capital intensive and do not exhibit high enough returns to fit their usual investment profiles) and Private Equity investors (i.e. PE investors are comfortable with higher-capital, lower return assets but not with any unproven technology or execution risks). And neither type of investor is comfortable with investment in an asset without employment or a clear revenue outcome, which would ensure the return of their capital. As a result, securing a commercial contract for the *Sea Change*, and in turn, having the ability to create robust

cash flow projections over the life of the asset, was the priority for obtaining (and resecuring after pandemic-related cancellations) any non-grant capital needed to complete the project.

Fortunately, SWITCH was able to start collaborating closely with the Water Emergency Transportation Authority (WETA), which controls the public SF Bay Ferry system, to explore a ‘demonstration’ lease period within their existing fleet. This concept hinged on WETA’s ability to secure sponsorship funds for the demonstration, since the operation of the additional vessel was not within their existing budget (and their operating budget was still very much in recovery from the pandemic). The *Sea Change* would be WETA’s first zero-emission ferry, acting as a compelling demonstration and creating many operational learnings in service of broader energy transition at SF Bay Ferry slated to be implemented over the coming decade. After securing sponsorship funds for a short 6-month commitment, WETA and SWITCH signed a new Bareboat Lease (a first for WETA) for the vessel - and the vessel was finally recontracted (albeit for a shorter commitment period than investors are comfortable with).

In the initial 6-month period, WETA will offer the ferry on a more tourist-focused route between the San Francisco Ferry Building to Pier 41 at Fisherman’s Wharf. There is an existing service on this route, and WETA will add the *Sea Change* for supplemental capacity, marketed as the first zero-emission ferry in the San Francisco Bay Ferry system. It is targeted to run ~5 days per week, with one 8-hour crew shift. The existing bareboat agreement with SF Bay Ferry indicates a 3-year term, with the ability for WETA to terminate after the first 6-months (which is the extent of the runway provided by their corporate sponsor supported budget, and therefore extent of the lease duration approved by the Board). When and if a longer-term financial commitment is secured with WETA (or another credit-worthy counterparty), SWITCH will look to replace the very ‘expensive’ project equity and debt capital with lower cost of capital sources, which will enable it to charge lower lease rates for the vessel in the future.

When and if the additional sponsorship and/or grant funds are secured, WETA could keep the *Sea Change* on the same route as the initial demonstration period, or it could transition the *Sea Change* to perform a new route in the system to accommodate potential sponsors, as a commuter-focused service with 2 x 8-hour crew shifts covering all-day commuting hour service, such as between the San Francisco Ferry Building and Mission Bay (the fastest growing neighborhood in San Francisco).

Once the vessel and technology have been proven to operate reliably in the demonstration period, SWITCH believes that the vessel can be utilized in more demanding routes in SF Bay. That said, because the vessel was originally designed by GGZEM with an orientation towards a grant demonstration project, the *Sea Change* is somewhat limited in the range of commercial opportunities it can service due to its small size, lower passenger capacity, and slower speeds relative to other vessels in the San Francisco Bay Ferry fleet. There are a few shorter routes that are a great fit, and those have been the focus for recontracting. (Note that these limitations do not apply to hydrogen fuel cell vessels in general. The core technology implemented in the *Sea Change* is modular and scalable and can power larger fuel cell electric vessels designed to operate on longer routes and at higher speeds).

As with an ‘first of its kind’ project that is a demonstration of new technology, the recipient of grant funds must balance what is considered technically feasible at the time of the grant application. However, in service of learnings for future CARB grant projects, SWITCH recommends that if any non-grant capital is required whatsoever for the completion of a project asset, the grantee should have a carefully considered plan for employment of the asset with sufficient contracted cash flow for a long enough duration to unlock project equity and/or debt. Grantees should also expect that such carefully considered commercial plans could/will very likely be turned upside down for any number of unexpected reasons, and should have created proactive backup commercial plans. SWITCH recommends this step be taken before grant applications are submitted, and recommends that CARB carefully assess any grantee’s ability to obtain private financing for at least double the projected cost. Such steps will lower the likelihood of stalled or failed grant projects due to

project financing when (not if) project completion costs are higher than originally expected in the grant application.

Vessel Completion

Throughout 2021, significant delays with the USCG permitting occurred (as previously detailed in regular grantor/grantee meetings but not necessary to detail in this report), until approval for initial commissioning operations was finally obtained by the shipyard in Q4 2021 and sea trials commenced. One of the primary barriers to adoption of hydrogen powertrain technology in the maritime sector stems from the lack of an established regulatory framework specific to hydrogen gas for ships. In the process of designing and constructing the *Sea Change* ferry, however, SWITCH has worked very closely with the USCG, leveraging regulatory frameworks for other low flashpoint fuels to develop a process for assessing and certifying the safety of the hydrogen system design. As a result of working through this USCG process, the *Sea Change* will hopefully act as a proof point that establishes a blueprint for the design and fueling of future maritime hydrogen projects that will be applicable to vessels of all types.

SWITCH completed seven successful hydrogen fuels during sea trials in Bellingham, WA, and received a letter of substantial completion from the USCG on Feb 28, 2022, at which point the vessel could be delivered from AAM upon final payment from SWITCH. Due to the aforementioned challenges with financing, the final payment to the shipyard was made in January 2023 and the vessel was transported to SF Bay in March 2023. Since delivery to SF, SWITCH has been working closely with WETA and its operator Blue & Gold Fleet. After an extended commissioning and permitting process in local SF waters, the vessel received its final Certificate of Inspection (COI) from the local USCG office in May 2024, which allows the vessel to carry passengers and enter commercial service.

The continued backdrop of the pandemic recovery for the passenger ferry sector, as well as need for WETA to have completed the demonstration period to prove operational reliability of the technology, have meant that securing a long-term commercial contract for *Sea Change* has not been straightforward. That said, certain tailwinds, like the growing pressure for heavy duty sectors to decarbonize (see CARB's recently passed amendment to the Commercial Harbor Craft regulation) and other large H₂-related grant funding opportunities, such as the DOE's upcoming Hydrogen Hubs, ensure that *Sea Change* will be relevant in California and other markets. The presence of the vessel in the SF Bay has already been having a positive impact on the perception of H₂-fueled transportation. Much of the higher costs of the project are related to delays, and can be attributed to much higher 'manhours' for shipyard and engineering throughout the much longer permitting process – more so than the hydrogen power equipment itself (addressed below in the discussion on costs).

Construction at Bay Ship & Yacht shipyard



Construction at All American Marine shipyard





Project Costs

The total cost of the project is \$14.3 million (as of March 31st, 2024 as the vessel commissioning and the grant project period concluded and no major additional costs expected), with the breakdown depicted below:

Project Costs	
Pre-Construction Costs (Technology, Design, Procurement, etc)	2,094,891.00
Shipyard Construction Costs	6,528,659.23
Non-Shipyard Construction Costs	2,262,642.92
Soft Costs / Commissioning	1,768,839.95
Construction Financing Costs	1,054,656.28
Hull Transport Costs	603,550.41
Capital Expenditures for Construction	\$ 14,313,239.79

Figure #7 - Sea Change Project Cost Summary

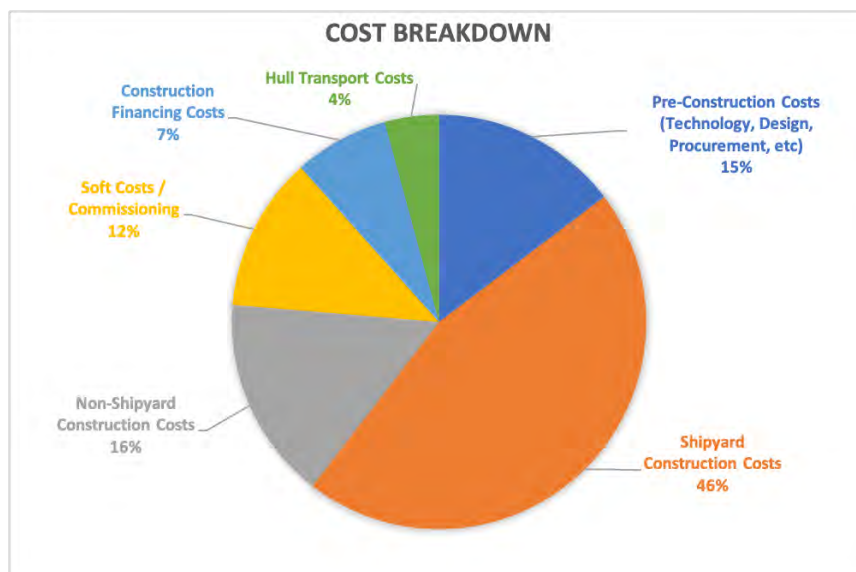

Figure #8 - Sea Change Project Cost Breakdown

The timing and flow of the total project spend are illustrated below:

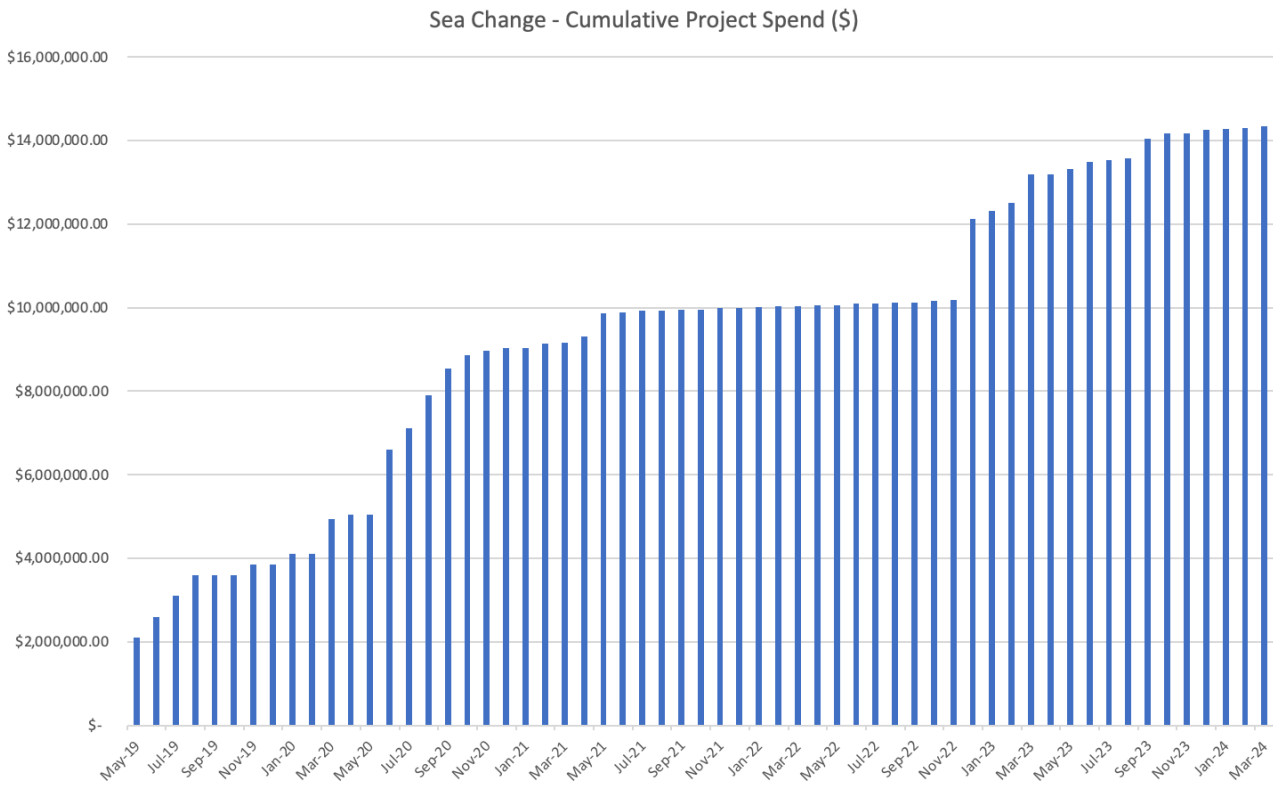

Figure #9 - Sea Change Costs Over Time

Discussion of One-Time Costs / Cost Reduction Potential for Future Builds

From SWITCH’s perspective as the ship owner, the total costs of the *Sea Change* project are more a reflection of the context and circumstances within which the project was completed, and less a reflection of the true cost of a hydrogen fuel cell powered vessel relative to its diesel-powered equivalent. Certainly, the *Sea Change* has been more expensive than a diesel equivalent, but there is a significant portion of one-time / first-time costs that should only be incurred on this build and not in future iterations.

It is very difficult (if not impossible due to so many moving parts and external factors at play) to tease out the exact portion of project totals related to specific delay or cost overrun drivers. To give a sense of the costs that would be repeated to build this same vessel again, SWITCH simply highlights the Shipyard Construction cost portion (46%) and Soft Costs/Commissioning cost portion (12%), which would equate to roughly \$8.3 million or less than 60% of the total *Sea Change* project costs (and even these portions should be materially less in the newbuild version if managed correctly by the shipowner in a ‘business as usual’ setting). Many of the other categories of costs were heavily inflated by the non-repeatable costs.

To be more specific, these non-repeatable costs can be separated into three distinct groups that SWITCH considers avoidable in its upcoming H2 ferry build program:

1. “One-time only” costs: SWITCH characterizes these costs as only occurring the first time this technology has been proven in the eyes of the USCG, the commercial counterparties and operators, the capital investor community, and the public. An example is the portion of the costs related to the fact that the permitting regime never existed in USCG policy (i.e. the word “hydrogen” has never been present in any USCG documentation before this project), and all the costs related to working through that will be to the benefit of all future builds for SWITCH and other shipowners. And there are too many examples of these costs to list in detail.

2. “First-time only” costs: SWITCH characterizes these costs as only occurring the first time this particular vessel design is approved, and equipment related to this particular vessel design (fuel cell types, storage tank sizes, safety equipment, etc) is approved. In other words, if SWITCH builds this same USCG-approved design again there would be many costs in the first build that would not need to be repeated in the second version. While there may be many improvements we make to this 75-pax design related to vessel #1 learnings (e.g. simplification of overly complex systems) and technological advancements over the last 5 years (e.g. fuel cell power density has increased over time), these would only require additional approvals under the same design criteria and permitting from the vessel #1 (much easier to obtain). However, if SWITCH builds a new, larger ferry design (e.g. 150-pax or 300-pax) to meet customer requirements, it would need to run that through a new ‘design basis’ approval process with the USCG. The new design permitting would benefit significantly from the previous *Sea Change* permitting, especially as SWITCH and its partners/vendors are aware of all of the design permitting learnings and ‘pitfalls’ to avoid. But there would be more ‘first-time only’ costs on a new size/design than if SWITCH just repeated the same exact design as the *Sea Change*. Additionally, if SWITCH decided to use different equipment/systems (e.g. liquid H2 storage tanks instead of gaseous H2 storage) on the new vessel design, that would add more engineering/permitting costs as the USCG would further need to understand the differences from the types of equipment that were previously approved in prior vessel builds.
3. “Circumstantial” costs: SWITCH characterizes these costs as only occurring in the specific context and time period that the *Sea Change* was built. These are costs and project structure related to the way the project developed before SWITCH’s involvement and the environment in which it had to operate in to complete the project. Again there are too many of these to list (most obvious being a global pandemic), but a good example is the contract structure that SWITCH needed to use to complete the project with the shipyard, which was a ‘Time & Materials’ contract in which the shipowner provides all ‘Owner’s Furnished Equipment’. To briefly summarize, the shipowner carries all the risk of permitting delays and cost overruns that can occur during a build, and has much less contractual leverage to manage shipyard costs throughout a build than if the shipyard works under a ‘fully wrapped’ build contract with performance guarantees and ‘not-to-exceed’ pricing that shares some of the risk with the shipyard. SWITCH fortunately worked with a very credible and supportive shipyards in the unique and challenging circumstances, but we highlight this one example as a project characteristic that SWITCH would never structure in a ‘business as usual’ setting – and just had to do whatever it took to get the project completed within the existing environment. Many of the costs in this category (e.g. related to delays, vendor/contractor challenges, etc) would be easily protected against in SWITCH’s upcoming build program.

At a high level, SWITCH estimates that the one-time / first-time / circumstantial costs equate to roughly 40% of the total project costs, or over \$6 million of the total \$14.3 million project cost. There is no way to control or avoid these costs to achieve this monumental milestone for the zero-emission transition within the maritime industry, and SWITCH is hugely grateful to all the project partners, capital providers, permitting agencies, operators, etc for the invaluable support as the project team navigated these first-ever challenges to bring the *Sea Change* project to completion – and ultimately endure the upfront pain to bring the industry that much closer to a zero-emission future.

Ferry Operation

The intended operational profile for the ferry is a short-hop route from San Francisco Pier 41 (near Fisherman's Wharf) to the Ferry Building. Outside of normal operating hours, the vessel is located at its homeport, the WETA Central Bay Operations and Maintenance Facility in Alameda, CA.

Route Characteristics:

- Round Trips / Day: 4 to 5
- One-Way Transit Distance: ~2.6 nautical miles
- One-Way Transit Time (Ferry Building – Pier 41): ~20 minutes
- Dwell Time: (Loading / Unloading) ~15 minutes
- Transit Speed: ~10 knots
- Operating Hours / Day: ~8 hours

Sample Operations:



Sea Change Service Route

The standard vessel operation was broken down into multiple subsegments for further analysis.

Subsegment #1 – At Berth

Fuel cells running, providing charging to the batteries but ship is not in motion, so no propulsive power provided.

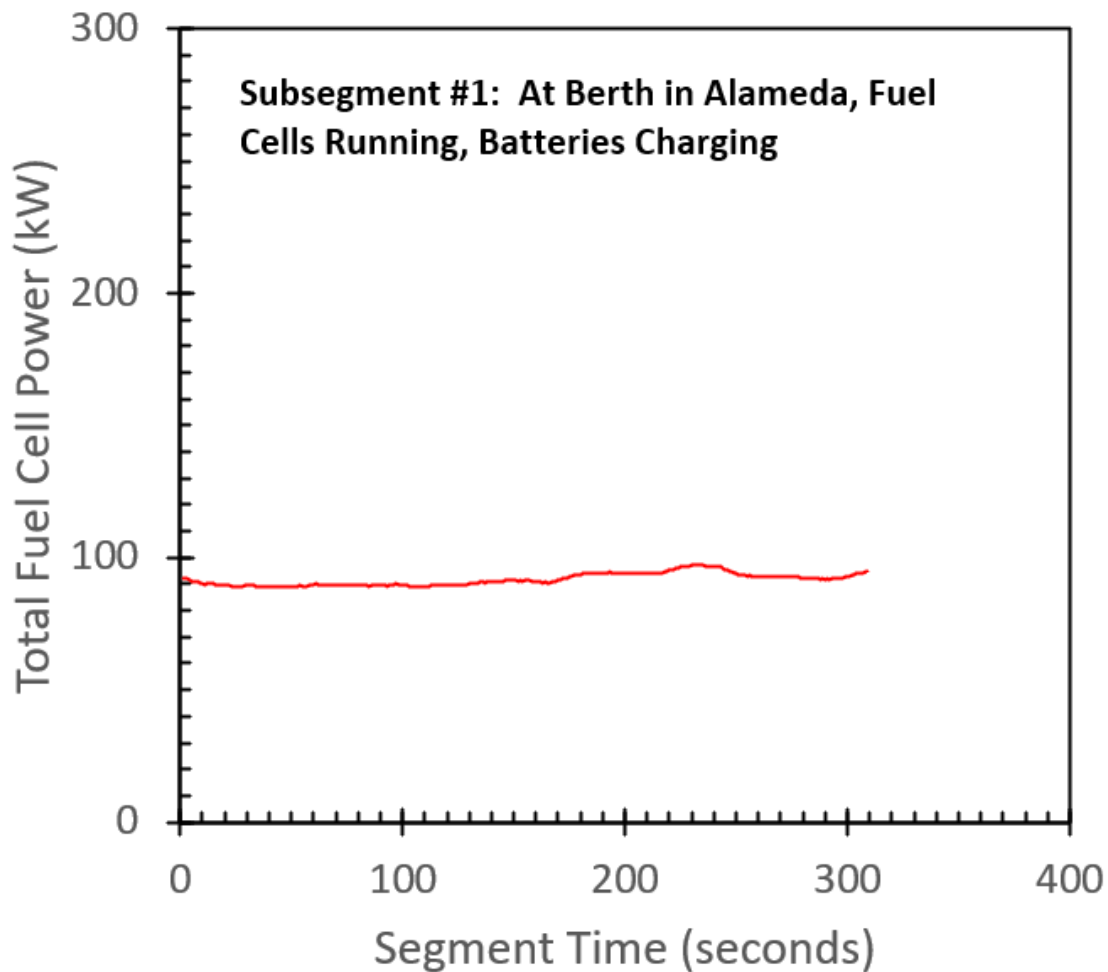

Figure #10 – Data Analysis Subsegment #1

Time Frame

- Date: 2/7/24
- Subsegment Time: 17:34:32 UTC to 17:44:40 UTC
- Data Analysis Segment Time for analysis HSS: 9:34:32 to 9:39:40.

Vessel Speed

- Speed During Subsegment: 0 kts

Hydrogen Tank Temperatures

- Avg. Tank Array 1 Temperature Before Data Analysis Segment: 48.6F = 282.4K
- Avg. Tank Array 2 Temperature Before Data Analysis Segment: 48.0F = 282.0 K
- Avg. Tank Array 1 Temperature After Data Analysis Segment: 48.4F = 282.3 K
- Avg. Tank Array 2 Temperature After Data Analysis Segment: 47.7F = 281.9 K

Hydrogen Tank Pressures

- PT200 (Tank Array 1) Pressure Before Data Analysis Segment: 1831.8 psig = 124.64 atm
- PT300 (Tank Array 2) Pressure Before Data Analysis Segment: 1870.9 psig = 127.3 atm
- PT200 (Tank Array 1) Pressure After Data Analysis Segment: 1826.1 psig = 124.3 atm
- PT300 (Tank Array 2) Pressure After Data Analysis Segment: 1863.7 psig = 126.8 atm

Hydrogen Mass

- Tank Array 1 H₂ Mass Before Segment: 60.80 kg
- Tank Array 2 H₂ Mass Before Segment: 73.74 kg
- Tank Array 1 H₂ Mass After Segment: 60.67 kg
- Tank Array 2 H₂ Mass After Segment: 73.50 kg

Fuel / Energy Consumption

- Total H₂ Mass Consumed During Segment: $0.13 + 0.24 = 0.37$ kg
- Hydrogen LHV energy consumed = 12.3 kWh (LHV of 1kg of H₂ = 33.33 kWh / kg).

Fuel Cell Data Inputs

- Fuel Cell Data Logging Subsegment Time Local: 9:31:02 to 9:36:10 PT
- Elapsed Time of Segment: 5 minutes, 8 seconds = 0.0855 hours
- Number of Fuel Cell Racks Turned On: 3
- Total Fuel Cell Power Output (Average over Data Analysis Subsegment): 93.4 kW (R1 @ 31.7 kW , R2 @ 6.5 kW , R3 @ 35.2 kW = 93.4 kW)
- % of Total Rated Power = $93.4 \text{ kW} / 360 \text{ kW} = 0.259 = 25.9\%$
- Total Electrical Energy Output During Data Analysis Segment: 7.98 kWh

Fuel Cell Efficiency

- Fuel Cell Efficiency at Avg. Power during Berth Data Analysis Segment:
- $7.98 \text{ kWh} / 12.3 \text{ kWh} = 64.9\%$

Subsegment #2 – Transit from Alameda Point to San Francisco Ferry Building

Vessel underway, fuel cells providing both propulsive power and battery charging when required.

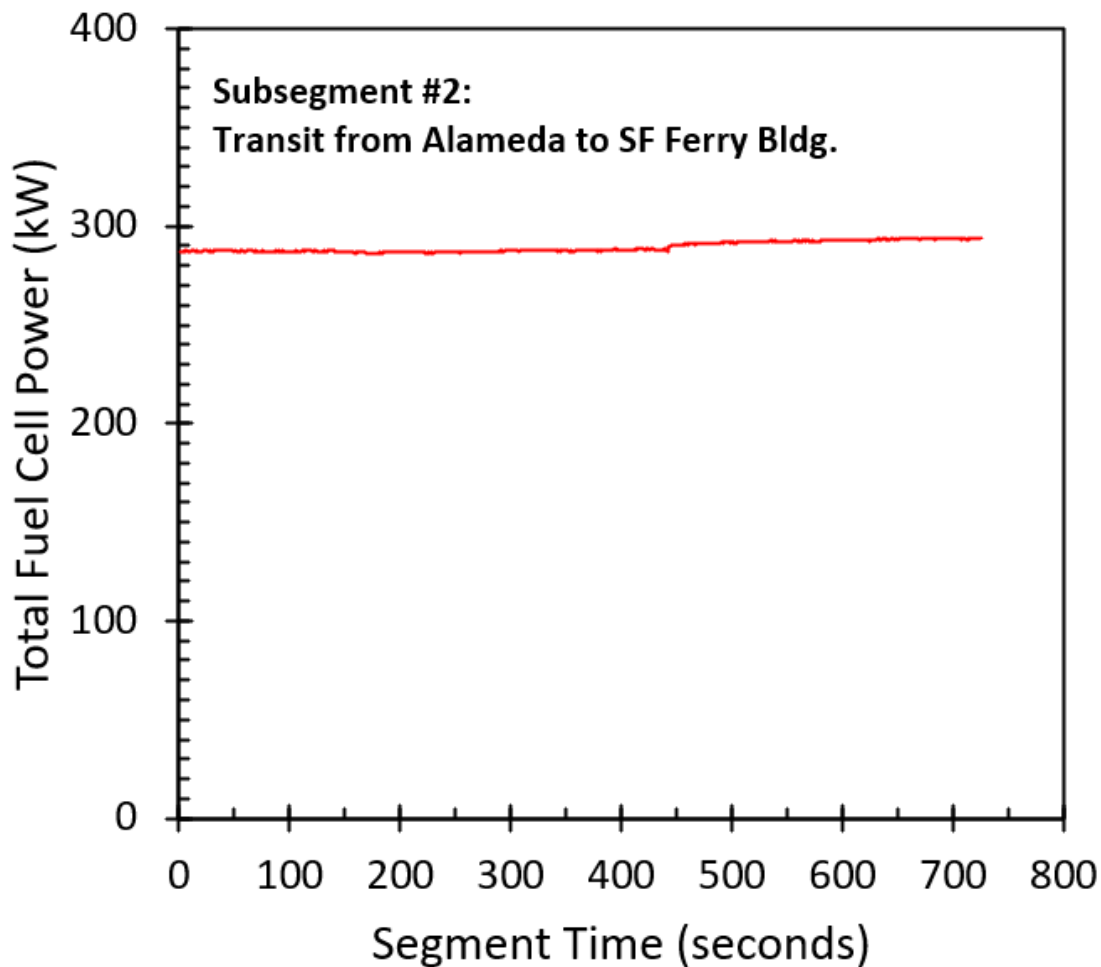

Figure #11 – Data Analysis Subsegment #2

Time Frame

- Date: 2/7/24
- Subsegment Time: 17:57:35 UTC to 18:14:49 UTC
- Data Analysis Segment Time for analysis HSS: 10:06:29 to 10:18:34.

Vessel Speed

- Speed During Subsegment: ~9 – 10 kts

Hydrogen Tank Temperatures

- Avg. Tank Array 1 Temperature Before Data Analysis Segment: 45.5F = 280.6 K
- Avg. Tank Array 2 Temperature Before Data Analysis Segment: 42.7F = 279.1 K
- Avg. Tank Array 1 Temperature After Data Analysis Segment: 43.5F = 279.5 K
- Avg. Tank Array 2 Temperature After Data Analysis Segment: 42.1F = 278.8 K

Hydrogen Tank Pressures

- PT200 (Tank Array 1) Pressure Before Data Analysis Segment: 1749.6 psig = 119.0 atm
- PT300 (Tank Array 2) Pressure Before Data Analysis Segment: 1732.3 psig = 117.9 atm
- PT200 (Tank Array 1) Pressure After Data Analysis Segment: 1697.4 psig = 115.5 atm
- PT300 (Tank Array 2) Pressure After Data Analysis Segment: 1700.4 psig = 115.7 atm

Hydrogen Mass

- Tank Array 1 H2 Mass Before Segment: 58.60 kg
- Tank Array 2 H2 Mass Before Segment: 69.37 kg
- Tank Array 1 H2 Mass After Segment: 57.22 kg
- Tank Array 2 H2 Mass After Segment: 68.24 kg

Fuel / Energy Consumption

- Total H2 Mass Consumed During Segment: $1.38 + 1.13 = 2.51$ kg
- Hydrogen LHV energy consumed = 83.66 kWh (LHV of 1kg of H₂ = 33.33 kWh / kg).

Fuel Cell Data Inputs

- Fuel Cell Data Logging Subsegment Time Local: 10:02:59 to 10:15:04 PT.
- Elapsed Time of Segment: 12 minutes, 5 seconds = 0.201 hours
- Number of Fuel Cell Racks Turned On: 3
- Total Fuel Cell Power Output (Average over Data Analysis Subsegment): 289.38 kW (R1 @ 103.95 kW, R2 @ 70.65 kW, R3 @ 114.78 kW = 289.38 kW)
- % of Total Rated Power = $289.38 \text{ kW} / 360 \text{ kW} = 0.804 = 80.4\%$
- Total Electrical Energy Output During Data Analysis Segment: 58.16 kWh

Fuel Cell Efficiency

- Fuel Cell Efficiency at Avg. Power during Transit Data Analysis Segment:
- $58.16 \text{ kWh} / 83.66 \text{ kWh} = 0.695 = 69.5\%$

Subsegment #3 – Transit from San Francisco Ferry Building to Alameda Point

Vessel underway, fuel cells providing both propulsive power and battery charging when required.

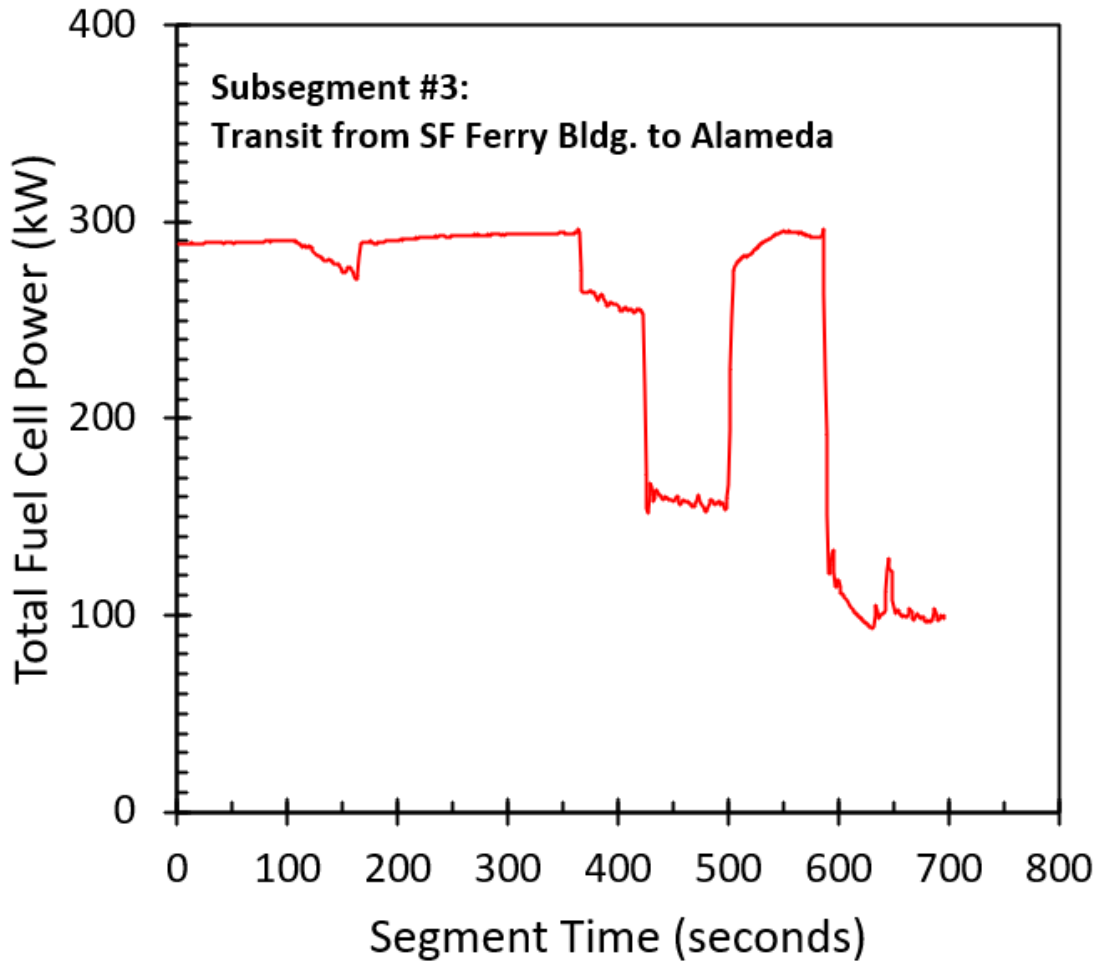

Figure #12 – Data Analysis Subsegment #3

Time Frame

- Date: 2/7/24
- Subsegment Time: 21:53:20 UTC to 22:18:15 UTC
- Data Analysis Segment Time for analysis HSS: 13:55:50 to 14:07:25.

Vessel Speed

- Speed During Subsegment: ~3 – 7.5 kts

Hydrogen Tank Temperatures

- Avg. Tank Array 1 Temperature Before Data Analysis Segment: 42.2F = 278.8K
- Avg. Tank Array 2 Temperature Before Data Analysis Segment: 40.7F = 278.0K
- Avg. Tank Array 1 Temperature After Data Analysis Segment: 44.3F = 280.0K
- Avg. Tank Array 2 Temperature After Data Analysis Segment: 41.3F = 278.3 K

Hydrogen Tank Pressures

- PT200 (Tank Array 1) Pressure Before Data Analysis Segment: 1154.7 psig = 78.57 atm

- PT300 (Tank Array 2) Pressure Before Data Analysis Segment: 1214.0 psig = 82.61 atm
- PT200 (Tank Array 1) Pressure After Data Analysis Segment: 1119.8 psig = 76.20 atm
- PT300 (Tank Array 2) Pressure After Data Analysis Segment: 1182.2 psig = 80.44 atm

Hydrogen Mass

- Tank Array 1 H2 Mass Before Segment: 39.96 kg
- Tank Array 2 H2 Mass Before Segment: 49.91 kg
- Tank Array 1 H2 Mass After Segment: 38.66 kg
- Tank Array 2 H2 Mass After Segment: 48.62 kg

Fuel / Energy Consumption

- Total H2 Mass Consumed During Segment: $1.30 + 1.29 = 2.59$ kg
- Hydrogen LHV energy consumed = 86.32kWh (LHV of 1kg H₂ = 33.33 kWh)

Fuel Cell Data Inputs

- Fuel Cell Data Logging Subsegment Time Local: 13:52:20 to 14:03:55 PT.
- Elapsed Time of Segment: 11 minutes, 35 seconds = 0.193 hours
- Number of Fuel Cell Racks Turned On: 3
- Total Fuel Cell Power Output (Average over Data Analysis Subsegment): 243.65 kW (R1 @ 87.29 kW, R2 @ 64.6 kW, R3 @ 92.92 kW = 244.81 kW)
- % of Total Rated Power = $243.65 \text{ kW} / 360 \text{ kW} = 0.677 = 67.7\%$
- Total Electrical Energy Output During Data Analysis Segment: 47.02 kWh

Fuel Cell Efficiency

- Fuel Cell Efficiency at Avg. Power during Berth Data Analysis Segment:
- $47.02 \text{ kWh} / 86.32 \text{ kWh} = 0.545 = 54.5\%$

Segment #4 – Entire Voyage

Vessel underway, fuel cells providing both propulsive power and battery charging when required.

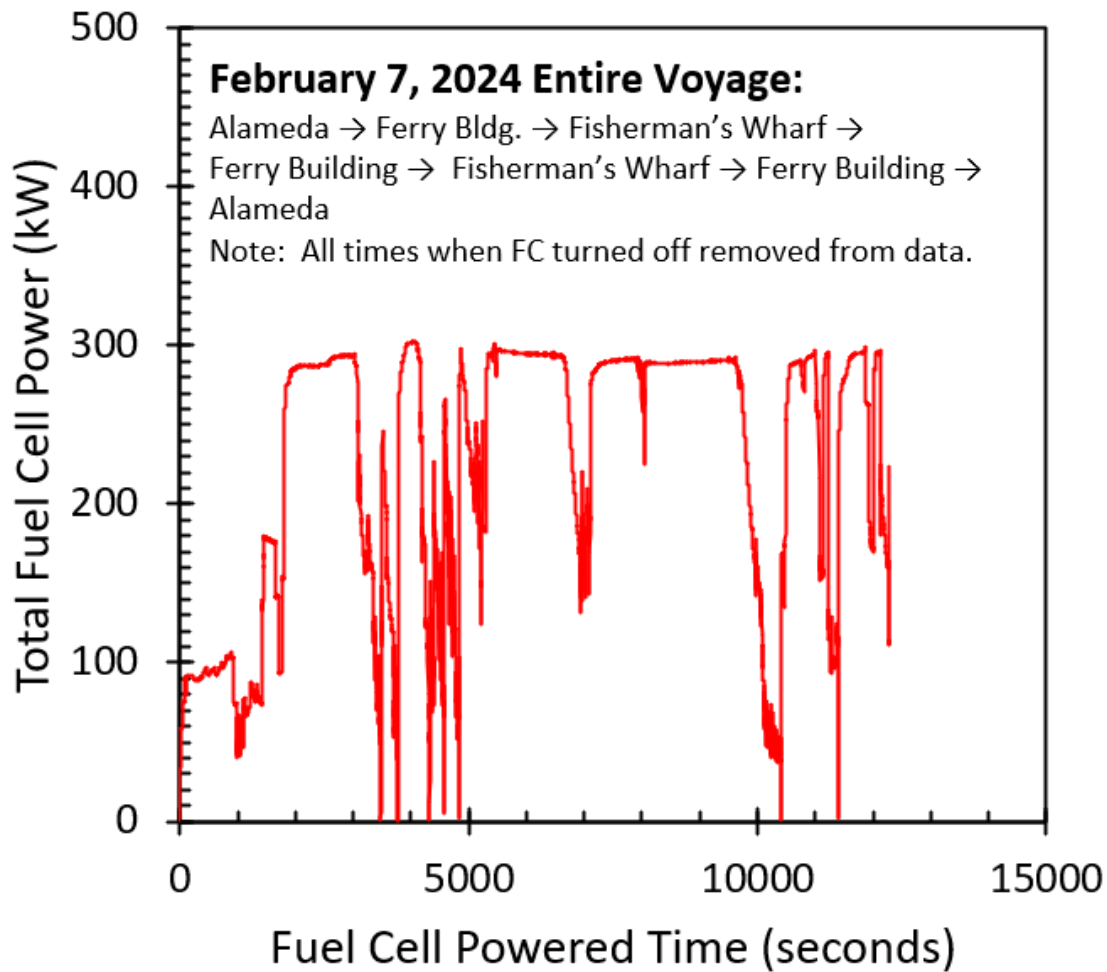

Figure #13 – Data Analysis Subsegment #4

Time Frame

- Date: 2/7/24
- Overall Segment Time: 17:34:32 UTC to 22:59:46 UTC (5 hours, 25 minutes, 14 sec)
- Overall Segment Time local (Pacific Standard Time): 9:34:32 to 14:59:46 PST.
- Fuel Cells First Turned On: 9:27:21 FCDL Time; Fuel Cells Last Turned Off: 14:22:19 FCDL Time
- HSS Time Fuel Cells First Turned On: 9:30:51, HSS Time Fuel Cells Last Turned Off: 14:25:49

Hydrogen Tank Temperatures

- Avg. Tank Array 1 Temperature Before Data Analysis Segment: 48.7F = 282.4K
- Avg. Tank Array 2 Temperature Before Data Analysis Segment: 48.5F = 282.3K
- Avg. Tank Array 1 Temperature After Data Analysis Segment: 48.1F = 282.1K
- Avg. Tank Array 2 Temperature After Data Analysis Segment: 43.2F = 279.3 K

Hydrogen Tank Pressures

- PT200 (Tank Array 1) Pressure Before Data Analysis Segment: 1853.3 psig = 126.1 atm
- PT300 (Tank Array 2) Pressure Before Data Analysis Segment: 1878.2 psig = 127.8 atm

- PT200 (Tank Array 1) Pressure After Data Analysis Segment: 1101.1 psig = 74.9 atm
- PT300 (Tank Array 2) Pressure After Data Analysis Segment: 1158.2 psig = 78.8 atm

Hydrogen Mass

- Tank Array 1 H2 Mass Before Segment: 61.46 kg
- Tank Array 2 H2 Mass Before Segment: 73.94 kg
- Tank Array 1 H2 Mass After Segment: 37.76 kg
- Tank Array 2 H2 Mass After Segment: 47.52 kg

Fuel / Energy Consumption

- Total H2 Mass Consumed During Segment: 23.7 + 26.42 = 50.12 kg
- Hydrogen LHV energy consumed = 1670.5 kWh (LHV of 1kg of H₂ = 33.33 kWh / kg).

Fuel Cell Data Inputs

- Total elapsed time fuel cells were Running during the voyage: 3.41 hours
- Total Fuel Cell Power Output (Average over Data Analysis Subsegment): 224.07 kW
- % of Total Rated Power = 224.07 kW/360 kW = 0.622 = 62.2%
- Total Electrical Energy Output During Data Analysis Segment: 764.1 kWh

Fuel Cell Efficiency

- Fuel Cell Efficiency at Avg. Power during Data Analysis Segment:
- 764.1 kWh/1670.5 kWh = 0.457 = 45.7%

Ferry Performance

The below table outlines the Sea Change’s average hydrogen consumption relative to its power output and speed under normal operating conditions. Average transit speed on the Pier 41 – Ferry Building generally falls between 8-11 knots, translating to a hydrogen consumption rate of between approximately 10 – 16 kg / hour and a resulting range of between 140 – 180 nautical miles before requiring refueling.

Despite some fluctuation in the average fuel cell efficiencies for each of the above operational subsegments, the long-duration fuel cell efficiency settled reliably at ~ 45%, aligned with the average efficiency of the overall journey segment. This indicates efficiency gains relative to diesel internal combustion engines, which tend to fall at around 35% efficient.

Sea Change Laden Performance					
RPM (r/min)	SPEED (knots)	Total BAE Power (kW)	H2 Consumption (kg / hr)	Range (nm)	Avg FC Efficiency (%)
0	0	24	1.62	0	44.4%
200	3.3	30.5	2.06	336.28	44.4%
300	4.65	58	3.92	249.18	44.4%
400	5.95	76	5.14	243.32	44.4%
450	7.15	99	6.69	224.47	44.4%
500	7.85	123	8.31	198.36	44.4%
550	8.7	154	10.44	175.01	44.3%
600	9.8	190	12.84	160.31	44.4%
650	10.7	236.5	15.98	140.62	44.4%
700	11.3	285.5	19.29	123.01	44.4%
750	11.9	342.5	23.14	107.99	44.4%
800	12.6	426.5	28.82	91.82	44.4%
850	13.55	508.5	34.36	82.82	44.4%

Table #1 – Sea Change Laden Performance

Notes:

*Range based on 210 kg total usable capacity

*Speed above FC max output (~300 kW) require battery boost and will have limited run time and require recharging time



Speed above FC max output (~300 kw) requires Battery Boost and will have limited run time and require recharging time.

Figure #14 – Sea Change Speed vs. Power Curve

Bunkering / Fuel Consumption

Fueling frequency has varied during commissioning period with bunkering events generally occurring 1-2x per week.

Sample Hydrogen Bunkering (Feb 8, 2024):

- Single trailer fueling, via cascade fill
- Total fill duration: 1 hour, 5 minutes
- Average fill rate: 1.26 kg / minute
- Total hydrogen fill quantity: ~82 kg

Operational Time Stamps:

- Vessel Alongside: 10:00am
- Trailer in Place: 10:15am
- Hose Connect to Vessel: 10:30am
- Start Transfer: 10:37am
- Finished Transfer: 11:42am
- Hose Disconnect: 11:45am
- Depart Vessel: 12:15pm

Bunkering Log:

Clock Time	Time Elapsed (Min)	Bottle	SOC (%)	SOC (kg)	Pressure (PSI)
10:37:00 AM	0:00	#1	25%	54	1262
10:45:00 AM	0:08	#2	28%	60	1330
10:50:00 AM	0:13	#3	31%	66	1417
10:55:00 AM	0:18	#4	34%	73	1510
11:00:00 AM	0:23	#5	37%	79	1600
11:04:00 AM	0:27	#6	40%	84	1686
11:09:00 AM	0:32	#7	43%	90	1720
11:13:00 AM	0:36	#8	45%	96	1854
11:17:00 AM	0:40	#9	48%	101	1932
11:21:00 AM	0:44	#10	50%	106	2010
11:24:00 AM	0:47	#11	53%	111	2090
11:28:00 AM	0:51	#12	55%	117	2170
11:32:00 AM	0:55	#13	57%	122	2245
11:36:00 AM	0:59	#14	60%	126	2315
11:39:00 AM	1:02	#15	62%	130	2390
11:42:00 AM	1:05	#16	64%	136	2460

Table #2 – Sea Change Bunkering Log

Duration and Volume:

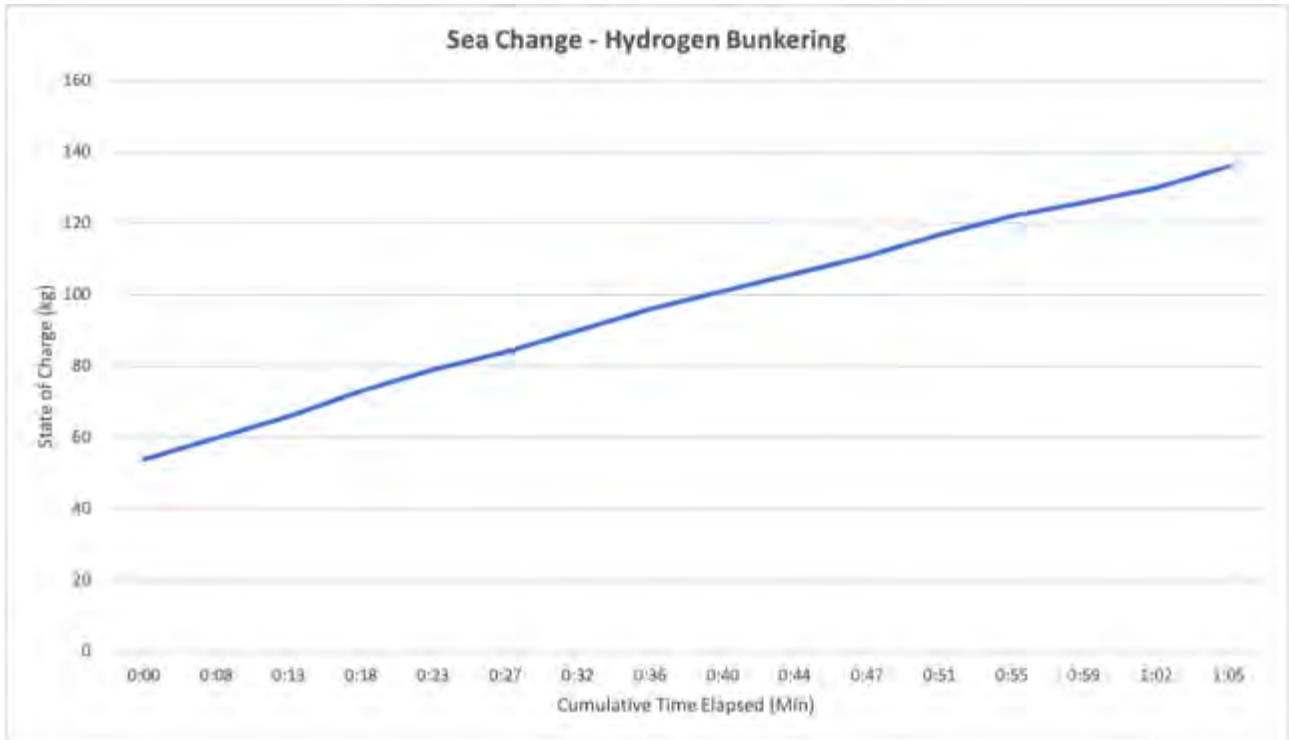

Figure #15 – Sea Change Hydrogen Bunkering Fill Rate

Hydrogen Truck Transport:



Hydrogen Truck Transport Route

Transit Distance: Approx. 80 miles from First Element Fuel fill station in Livermore, CA.

Ferry Transit Distance To Hydrogen Bunkering:

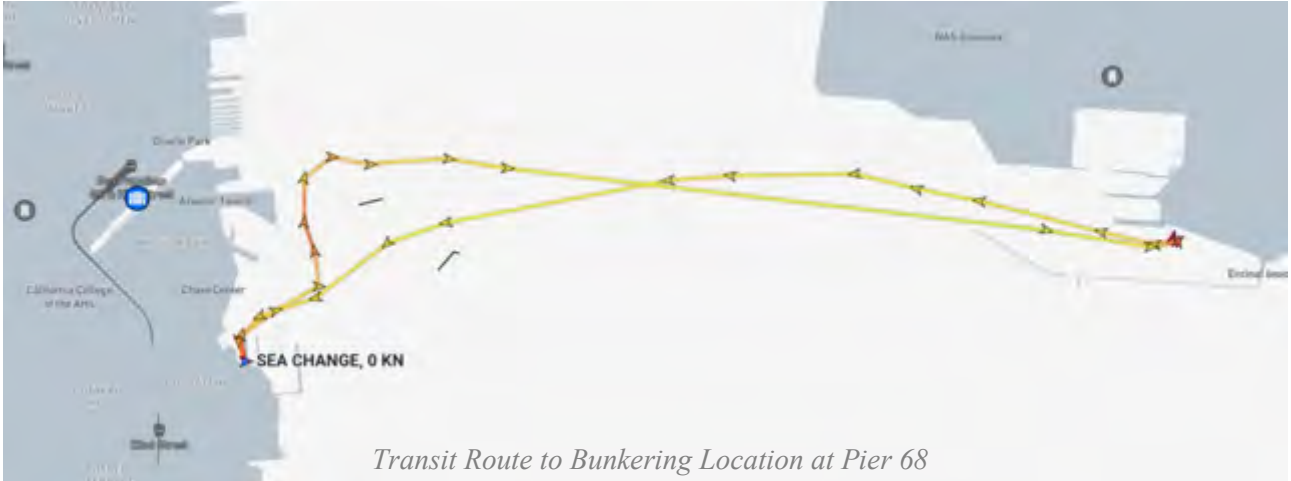

Transit Route to Bunkering Location at Pier 68

Transit Distance: Approx. 4.5 nautical miles from WETA Central Bay Operations and Maintenance Facility in Alameda, CA to hydrogen fueling location at San Francisco Pier 68.

Fueling Process:

Supplying the *Sea Change* with hydrogen occurs with a truck-to-ship fueling, paralleling established industry practices. Each hydrogen fueling starts with an official notification that is sent out 4 – 24 hours prior to the bunkering event by the vessel operator to all involved parties including the Port of San Francisco, USCG, and Fire Department. On the vessel side, the crew turns to, performs a standard vessel start up procedure, and then commences a transit to Pier 68, the permitted site for hydrogen fueling. Upon vessel and hydrogen trailer arrival, the crew designates roles and responsibilities (person in charge or PIC, safety and security officer, etc), establishes a secure perimeter around the fueling area, and reviews a pre-fueling safety checklist. Once complete, the bunkering hose can be connected and fill begins. Set up and breakdown each take around 30 minutes before and after fueling events.



Project Team and USCG Assemble to Review Pre-Bunkering Checklists

When all pre-bunkering checklists have been satisfied, the vessel PIC enters the vessel's pilot house and begins an automated bunkering process on a computer referred to as the hydrogen storage system panel or HSS panel. During bunkering, the vessel PIC communicates with the truck PIC via radio providing clear communication and guidance about each step of the process. The automated instructions that are presented to the vessel PIC entail the following six steps: (1) Pre-Fill Setup, (2) Pre-Fill Inert, (3) High Pressure Leak Check, (4) Fill, (5) Post-Fill Inert, (6) Post-Fill Clean Up.

For safety reasons, fuel cells are not operated simultaneously during bunkering. As a result of this restriction, the vessel operator ensures that upon arrival to the bunkering location the vessel's batteries are maximally charged, as they will be the primary source of energy supporting the vessel's house loads during fueling. As fueling progresses, most all the vessel's primary systems (pumps, fans, etc) remain functional and slowly drain the battery level over time. Given that each hull contains 50 kWh of battery capacity and the house load per side (Port & Starboard) averages ~6 kW, the vessel operator has at most ~5.5 hours of battery life (assumes start with ~85% state of charge and never going below 20% state of charge) to complete bunkering.



Sea Change Bunkering

Infrastructure Reliability:

The high pressure compressed gas trailer delivering hydrogen to the Sea Change has proven to be very reliable. On the Sea Change, the majority of fueling events progressed smoothly and without reliability issues. However, a select few issues impeded progress on certain bunkering events and required maintenance or troubleshooting before being able to proceed. The individual instances mentioned below fall under one of two categories, either (1) requiring bunkering to be aborted and rescheduled, (2) bunkering successful with room for improvement.

Bunkering Aborted and Rescheduled

- Instance #1: A solenoid valve on the top deck of the Sea Change, which under normal circumstances, is supposed to open all the way to let hydrogen flow through, was determined to be “sticky” and not opening fully. This caused hydrogen to flow from the truck to the vessel but only extremely slowly. Only ~14 kgs were transferred before the bunkering aborted and rescheduled. Following a rebuild of the solenoid valve in question, the issue has not returned.
- Instance #2: During the automated bunkering process, the computer system did not successfully progress through the Pre-Fill Inert process, and for good reason. Upon doing an inspection of the potential reasons for the issue, a gas leak was identified on a swivel fitting near the bunkering hose reel. No hydrogen was flowing at the time (only a pre-fill leak with nitrogen gas) and no danger was present. The system’s safety steps worked as they should have, the leak point was identified, and the fitting was successfully replaced a day later enabling bunkering to be rescheduled.

Bunkering Successful, Room for Improvement

- The automated bunkering process is controlled by software loaded on a programmable logic controller (PLC). The vessel PIC is trained to a level of expertise where that individual is able to progress through the automated system’s instructions / dialogues. The vessel PIC is not, however, a highly trained technician that is capable of doing manual overrides of the automated system in cases where the automation is not performing as expected. There have been a few select instances where a technician from ZEI has had to assist the vessel PIC by performing a manual override and/or updating the PLC software in order to progress smoothly. Some fine tuning was expected during commissioning and any such issues that presented themselves were generally resolved in short order.

Hydrogen Price:

Hydrogen market conditions have fluctuated during the vessel’s operations in the San Francisco Bay Area, but prices for the molecule have averaged around ~\$30 / kg of hydrogen.

Currently this cost of hydrogen translates to approximately 10x the cost of diesel. While it’s currently a significant premium to diesel, that cost premium represents only around a ~20% increase in the annual operating cost of the vessel relative to the baseline.

The below table shows a comparison between various fuels at certain price levels. This specifically shows a \$30 / kg cost of hydrogen relative to a \$3.50 / gallon cost of diesel fuel. The conversions account for the differences in energy content between fuels, enabling an apples-to-apples comparison. Specifically, a \$30 / kg price of hydrogen translates to an equivalent \$36.24 / gallon for diesel. Viewed another way, a \$3.50 / gallon cost of diesel translates to an equivalent price of hydrogen of \$2.90.

Fuel	\$/kg	\$/mt	\$/gal	\$/cbm	\$/mmBtu
Hydrogen	\$ 30.00	\$ 30,000.00	\$ 8.04	\$ 2,123.31	\$ 263.79
LNG Equivalent	\$ 12.24	\$ 12,241.22	\$ 21.80	\$ 5,759.18	\$ 263.79
Diesel Equivalent	\$ 11.38	\$ 11,376.15	\$ 36.24	\$ 9,573.54	\$ 263.79
MGO Equivalent	\$ 11.25	\$ 11,251.13	\$ 36.51	\$ 9,645.60	\$ 263.79
VLSFO Equivalent	\$ 10.40	\$ 10,401.05	\$ 37.16	\$ 9,816.51	\$ 263.79
Diesel	\$ 1.10	\$ 1,098.70	\$ 3.50	\$ 924.60	\$ 25.48
Hydrogen Equivalent	\$ 2.90	\$ 2,897.37	\$ 0.78	\$ 205.07	\$ 25.48
LNG Equivalent	\$ 1.18	\$ 1,182.24	\$ 2.11	\$ 556.22	\$ 25.48
MGO Equivalent	\$ 1.09	\$ 1,086.62	\$ 3.53	\$ 931.56	\$ 25.48
VLSFO Equivalent	\$ 1.00	\$ 1,004.52	\$ 3.59	\$ 948.07	\$ 25.48

Figure #16 – Hydrogen vs. Diesel Price Comparison

Taking this one step further, the below side-by-side comparison shows an assessment of hydrogen vs. diesel costs, normalized for the same operational energy requirement. That is, the assessment fits the operational expectations for the Sea Change, which consumes ~100 kg / day on its intended service route.

Hydrogen		Diesel	
<u>Inputs - Energy Density</u>		<u>Inputs - Energy Density</u>	
Gravimetric	120.0 MJ/kg 33.33 kWh/kg 0.11 mmBtu/kg 113.73 mmBtu/mt	Gravimetric	45.5 MJ/kg 12.6 kWh/kg 0.04 mmBtu/kg 43.13 mmBtu/mt
Volumetric	1.7 kWh/liter H2 at 500 bar 0.01 mmBtu/gal H2 at 500 bar 3.75 mmBtu/cbm H2 at 500 bar 1.7 kWh/liter H2 at 700 bar 0.02 mmBtu/gal H2 at 700 bar 4.78 mmBtu/cbm H2 at 700 bar 1.55 kWh/liter LH2 0.03 mmBtu/gal LH2 8.05 mmBtu/cbm LH2	Volumetric	0.13 mmBtu/gal 36.29 mmBtu/cbm
<u>Inputs - Fuel Pricing</u>		<u>Inputs - Fuel Pricing</u>	
Delivered molecule price	\$ 30,000.00 \$/kg \$ 30,000.00 \$/mt	Delivered molecule price	\$ 1.10 \$/kg \$ 1,098.70 \$/mt
	\$ 8.04 \$/gal LH2 \$ 2,123.31 \$/cbm LH2		\$ 2.50 \$/gal \$ 924.60 \$/cbm 0.04 \$/gal urea
	\$ 263.79 \$/mmBtu		\$ 25.48 \$/mmBtu
<u>Inputs - Powertrain Efficiency</u>		<u>Inputs - Powertrain Efficiency</u>	
Fuel cell	40%	Diesel Engine	35%
<u>Inputs - Vessel Energy Requirement</u>		<u>Inputs - Vessel Energy Requirement</u>	
Energy requirement	5 mmBtu/day 5 mmBtu/voyage	Energy requirement	5 mmBtu/day 5 mmBtu/voyage
<u>Outputs - Fuel Requirement</u>		<u>Outputs - Fuel Requirement</u>	
Mass	100 kg H2/day 100 kg H2/voyage	Mass	339 kg Diesel/day 339 kg Diesel/voyage
	0 mt H2/day 0 mt H2/voyage		0 mt Diesel/day 0 mt Diesel/voyage
Volume	1 cbm LH2/day 1 cbm LH2/voyage	Volume	0 cbm Diesel/day 0 cbm Diesel/voyage
	373 gal LH2/day 373 gal LH2/voyage		106 gal Diesel/day 106 gal Diesel/voyage
<u>Outputs - Fuel Cost</u>		<u>Outputs - Fuel Cost</u>	
	3,000 \$/day 3,000 \$/voyage		383 \$/day 383 \$/voyage
<u>Outputs - Premium / Discount</u>		<u>Outputs - Premium / Discount</u>	
Relative to LNG	1260%	Relative to Hydrogen	-87%
Relative to Diesel	683%	Relative to LNG	74%
Relative to MGO	2695%	Relative to MGO	257%
Relative to VLSFO	2781%	Relative to VLSFO	268%

Figure #17 – Hydrogen vs. Diesel Operational Price Comparison

Hydrogen Carbon Content:

Fuel supply for SWITCH zero-emissions vessels may be thought of in a phased approach. In the short-term, hydrogen supply will be delivered by truck: the mobile trucking solution has been chosen strategically for the short-term as a way to avoid the many permitting hurdles associated with permanent land-side infrastructure. As SWITCH progresses towards additional vessels, it plans to build its own more permanent green hydrogen fueling infrastructure (produced via electrolysis with renewable power) to service the fleet with a focus on co-locating hydrogen production with demand to reduce the transit distances involved in fuel distribution.

Until this dedicated supply chain is completed, SWITCH is leveraging the hydrogen supply that is currently available in the San Francisco Bay Area, which is the same H₂ that the automotive fueling stations in the Bay Area use. Because the volumes required for the *Sea Change* are relatively small (up to ~200 kg / day), this is a viable short-term solution.

Getting to a full zero-carbon supply chain that is economically viable will take some time, and in the short term the specific renewable content that is delivered to *Sea Change* depends on hydrogen market conditions. Over time, building additional vessels that use significant quantities of hydrogen will be an important force that allows for the establishment of robust, dedicated fuel supply chains, increased volumes of green hydrogen production, and ultimately lower fuel costs.

Total Cost of Ownership:

Generally, SWITCH considers total cost of ownership (TCO) over the life of the asset the most informative view for assessing cost premiums/discounts relative to conventional vessels. The three primary categories comprising the TCO for a vessel are: CapEx, Service & Maintenance, and Fuel.

SWITCH sees forward-looking cost curves for both hydrogen fuel and CapEx declining over time with increased scale of hydrogen and fuel cell production. The reduction in moving parts associated with zero emissions vessels means that service and maintenance is expected to result in discounts relative to conventional options. Overall, cost-parity is expected to be achieved in the next 5-7 years with grants and incentives helping to offset premiums in the near-term.

Note the below TCO graphs are based on a theoretical comparison between a zero-emissions fuel cell electric ferry (modeled after *Sea Change* - passenger capacity, powertrain, etc) and a similar conventional sized diesel internal combustion engine ferry. The underlying inputs and assumptions for this analysis are based on the best available market data and forward-looking cost curves, however, uncertainty is inherent in models of the future and these predictions are subject to change and refinement over time.

This graph shows the projected premium / discount for a zero emissions vessel by year of construction / delivery. For example, a vessel constructed in 2029 would be expected to approximately achieve cost parity on a TCO basis with its similar diesel counterpart (over the full life of the vessel).

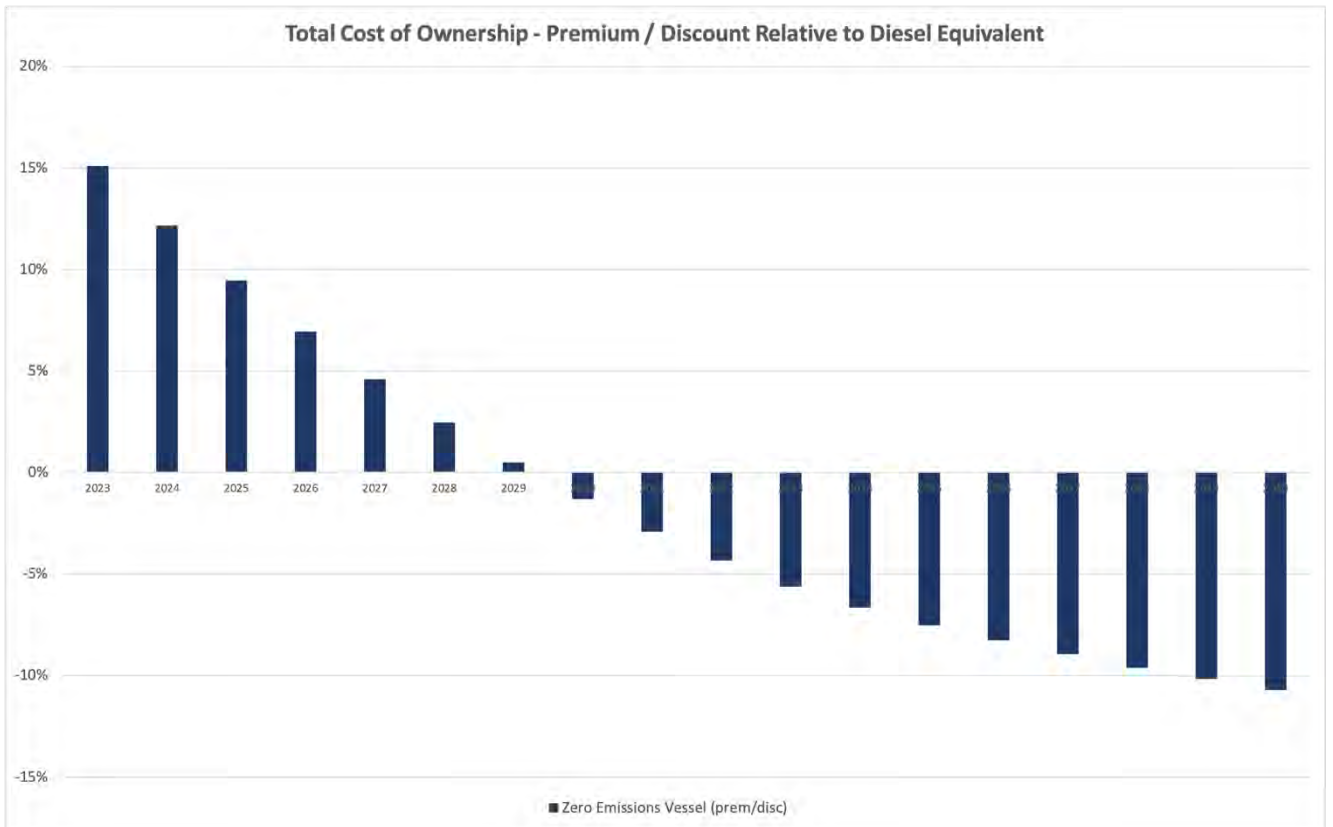

Figure #18 – Total Cost of Ownership, Premium / Discount Relative to Diesel Equivalent

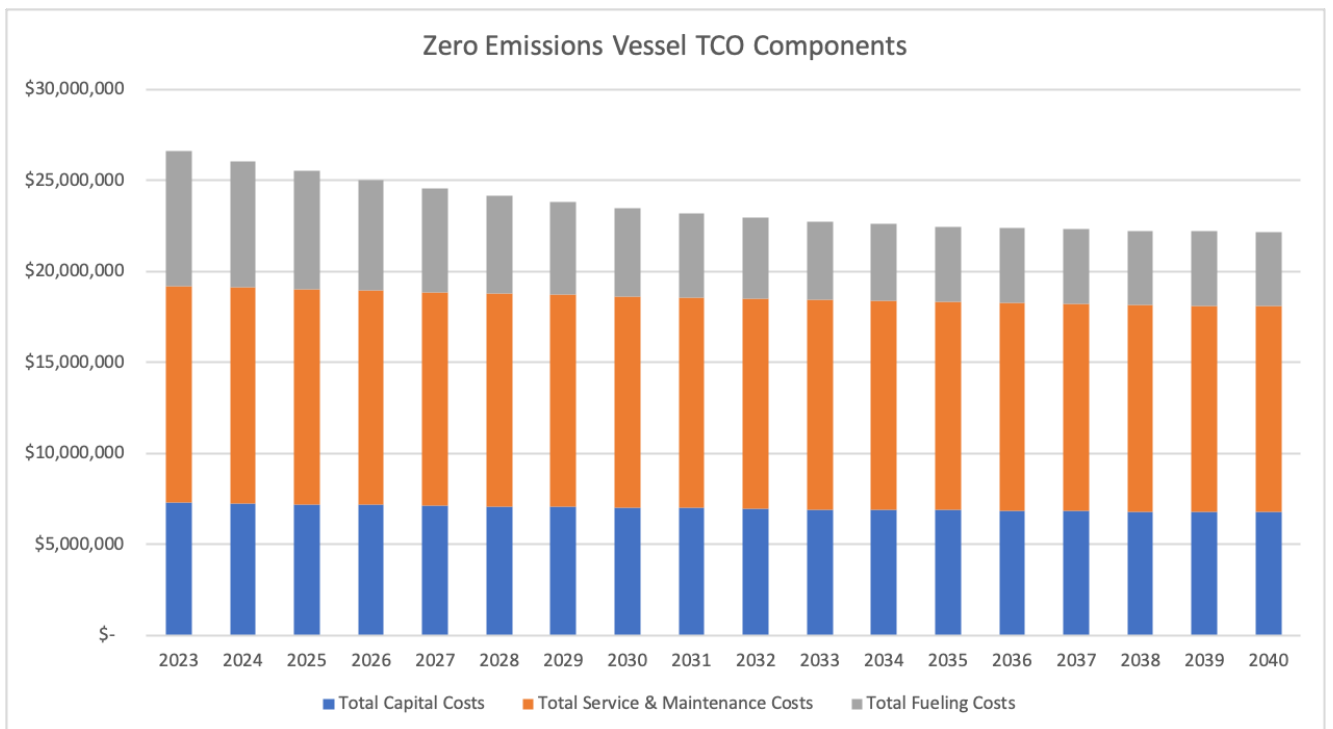

Figure #19 – Total Cost of Ownership Components

Most importantly, SWITCH ultimately views the move to zero emissions vessels as more than just a decision about cost. For many operators, the benefits of securing a “future-proofed” vessel that is impervious to any future emissions regulations will outweigh the costs.

Maintenance

The below chart details an overview of the scheduled/planned maintenance items for the Sea Change powertrain system and the corresponding service intervals:

Action	Service Interval																
	14 dy	1 mo	3 mo	500 hr	6 mo	1 yr	3000 hr †	2 yr	6000 hr †	3 yr	3.5 yr*	5 yr*	5.5 yr*	6 yr*	5-10 yr*	20 yr*	
●: Performed by operator																	
◆: Performed by technician																	
○, ◊: Alternative service interval, see accompanying note																	
	Daily																
Check ACTM Coolant Level	●																
Check coolant level in APS, PCS, and PIM	●																
Check FC's internal DI water level and fill if needed	●																
Check FC coolant level and resistivity		●															
Check ACTM for oil leaks			●														
Inspect electrical connectors and wiring for looseness and damage			●														
Inspect cooling system connections and seals for leaks or damage			●														
Inspect FC intake air filter for obstruction and debris			●														
Inspect salt fog filter obstruction and debris (FC room filter)			●														
Replace ACTM oil and filter				●													
Inspect ESS air filters for obstruction and debris				●													
Examine FC inlets and outlets for obstructions				●													
Examine FC for physical deterioration				●													
Examine hydrogen gas detectors for damage/obstruction				●													
Inspect FC module for leakage by issuing a "leak check" command							†										
Check that hydrogen supply pressure to the FC is within specification							†										
Inspect and clean FC coolant strainer							†										
Calibrate hydrogen gas detectors								◆									
Inspect hydrogen system relief valves and vent piping for damage, obstructions, water build-up.								●									
Inspect FC's Hydrogen Purge Solenoid Valve and clean and/or replace plunger pad if necessary																	
Drain ACTM oil system and clean oil pump																	
Replace ACTM Yoke Nut and Clamping Washer (more often if radial movement of the yoke on the output shaft is observed)																	
Replace FC DI circuit deionization filter media																	
Inspect hydrogen piping/tubing, valves, and fittings for damage and corrosion including at contact points and under clamps/pipe supports																	
Verify hydrogen tank cycle count <750																	
Replace or clean ESS air filters																	
Replace FC air filter																	
Replace FC room filter (salt fog filter)																	
Inspect coolant pump for excessive leakage																	
Inspect all vibration isolators for damage/wear																	
Inspect ESS high voltage cables and harnesses for chaffing and intact external sheathing																	
Inspect ESS LV and HV connectors are fully seated and free of liquid																	

house, notifying the vessel operator of an issue. At certain junctures during system testing, automation issues were identified (e.g. fan is turned off, yet loss of ventilation alarm fails to trigger in pilot house) that required software updates. While these issues slowed down completion of testing at times, they generally did not result in time out of service and were able to be resolved with remote computer support within hours.

- A recurring “phantom” fault on the starboard side computer display in the pilot required an onsite visit from BAE to assess the root cause of the display registering an HSS / FC fault despite the fact that the systems remained online and in good function. The issue turned out to be diagnosed as a CAN network communication problem and was resolved with a software update to adjust the timing of CAN messages. This required approximately 3 days of the vendor’s time before it was resolved.
- Hardware
 - The primary hardware issue with the fuel cell system pertained to failing recirculation pumps and/or fuse failures in the printed circuit board (PCB). When a recirculation pump would fail, it would present itself to the operator because the fuel cell module in question would fail to successfully start up. Once failed, a spare recirculation pump was required as well as a trained technician to perform the installation, which could result in a up to ~3 days of time out of service based on availability of spares and technician schedules. After reappearing a number of times, the true upstream issue causing the recirculation pump failures was ultimately identified and addressed. With the aid of screen recordings and detailed event logs of the fuel cell system, the failures were identified as coincident with hydrogen pressure levels that were lower than the rated pressure required by the fuel cells. By adjusting the pressure control valve in the hydrogen storage system that regulated hydrogen pressure to the fuel cells, the pressure at the racks was improved and the recirculation pump failures stopped occurring.
 - The second critical hardware issue that presented itself and required repair were related to the battery disconnect unit or BDU, which is a device used to isolate a battery or bank of batteries from the electrical system of a vehicle or equipment. The BDU serves as a safety measure, allowing users to disconnect power from the battery for maintenance, servicing, or in case of emergencies. As part of PSTP testing process for the USCG, the project team had to simulate multiple emergency scenarios where the operator was required to press one of the red “E-Stop” buttons on the vessel. Under normal operating circumstances, such E-Stops would rarely, if ever, be pressed (only under serious emergency situations); however, during PSTP testing multiple E-Stop tests were required. This repeated E-Stop testing had the downstream effect of frequently forcing contactors in the BDU to open under load, which resulted in incremental damage to the unit. Over time, the contactors in the BDU were identified as “welded” (i.e. not opening and closing properly), and required the piece of hardware to be replaced by a trained technician. This fix required up to ~5 days out of service due to availability of spares and technician schedules.

Safety

No notable incidents occurred where safety was compromised.

User Experience

One of the primary differences in passenger experience is reduced noise and vibration. When the Sea Change is underway, the loudest pieces of equipment are the pumps and fans, providing cooling to the electric motor and ventilation of the battery compartment. A low but audible whirring noise is heard when the fuel cells are starting up, but then drifts into the background once underway.

For the operator, the responsiveness of the electric propulsion system is a significant positive feature that has been noted. For example, during crash stop tests, the vessel does not require any delay between shifting out of forward and into reverse. This immediate response enhances the vessel's operational safety characteristics.

As the Sea Change is operated for longer durations in passenger service, additional user experience will be gathered.

Lessons Learned – Discussion of Pertinent Issues or Problems

Successfully completing the design, construction, and operationalization of *Sea Change* required the coordination of many project participants to navigate challenges, both foreseen and unforeseen. Broadly speaking, the issues encountered along the path to completion fall into the following categories, each of which will be described in further detail below: project team experience, shipyard selection, Acts of God or Force Majeure events (e.g. pandemic-related impacts), project costs and financing, regulatory approvals, operation and maintenance of new tech, and fuel supply. The team's hard work and determination to see the first-of-kind project to fruition despite the roadblocks encountered has created a foundation for further integration of zero-emissions powertrain technology in US commercial harbor craft and beyond, accelerating maritime decarbonization goals.

Project Team Experience and Shipyard Selection

In retrospect, the production-level engineering drawing dispute that emerged early in the project was a signal that the intricacies of US shipbuilding are best managed by a team of construction management experts with deep industry knowledge. Further, it was a signal that the selection of newbuild shipyard(s) with a demonstrated track record of advanced technology integration would maximize the chances of project success, over shipyard(s) whose core competency is vessel repair and maintenance. Finally, from a financial perspective, because GGZEM was a start-up company, it had no real ability to weather serious deviations from project cost or timeline projections in order to fulfil its contractual obligation to deliver a completed vessel to SWITCH. At this critical juncture in the project trajectory, SWITCH also had no real recourse to recoup the funds it had extended via the promissory note due to GGZEM's status as a new company. This set of realities, along with a strong mission-driven orientation, led the SWITCH to assume greater responsibility, risk, and cost as it embarked on the next phase of construction.

Opting for an alternative trajectory in order to keep the project moving forward also meant adding a layer of time and money that was not dedicated to ship construction but to administration, legal costs, transportation, etc. Cancellation of the first shipbuilding agreement, running a shipyard selection process, engaging an expert construction management team, hiring barges for vessel and equipment transportation to and from the newly selected shipyard, amending numerous contracts to accommodate for project timeline shifts, and hiring regulatory consultants to assist with the USCG approval process contributed to material project cost increases.

As mentioned previously, future similar grant projects would benefit from requiring the grantee to craft a carefully considered plan for project financing that is capable of weathering significant cost and timeline overruns.

COVID Impacts / Commercialization

Just as the team was shipping the partially constructed vessel hull on a barge to the new shipbuilder, COVID shut down specific states and eventually, the entire nation. Soon after the half-built vessel left Bay Ship & Yacht in California and arrived in Bellingham, WA at All American Marine, the state of Washington ordered a shutdown of non-essential businesses, which included the shipyard. While the immediate impact of the shipyard shutdown was relatively short-lived, the larger, more serious COVID-related challenges emerged over time, including supply chain issues, increased cost of materials and equipment, travel restrictions and quarantine mandates, and negative impacts to vessel commercialization prospects as the passenger ferry industry was decimated overnight.

While it is unlikely that such a significant set of adverse conditions for commercialization re-emerge in the near future, one beneficial step that SWITCH believes CARB and other similar agencies could take to accelerate the commercialization of zero emissions vessels is providing more grant funding opportunities that support municipal operating budgets (as opposed to capital projects). In this way, more municipal ferry

operators would be able to take advantage of the strategic benefits of leasing zero-emissions vessel into their fleet rather than being restricted to vessel ownership. More specifically, a lease model provides the municipality added optionality and flexibility in their long-term decarbonization trajectory – given the rapid pace of technology advancement, instead of being stuck with an asset for the entirety of its useful life, an operator could “trade” or “upgrade” to leasing the next best version every 5-10 years without the pressure of making irreversible 25+ year decisions today with imperfect information.

Regulatory

Navigating regulatory challenges and establishing a framework for future hydrogen-fueled vessels was undoubtedly one of the greatest accomplishments of the project. As process of outfitting the vessel with its equipment began in earnest at All American Marine, so too did increased regulatory hurdles. While codes and standards existed for transfer and use of hydrogen on land (e.g. NFPA 2²) and in other low flashpoint fuels like LNG for the maritime industry (e.g. IGF Code³), prior to this project no regulatory framework for hydrogen in maritime had existed. Consequently, the process of ultimately achieving a USCG approved vessel started with a lot of baseline education about hydrogen and its properties as well as conducting extensive HAZ ID and Risk Assessment meetings. With safety as the number one priority, and rightly so, the process of obtaining approvals proved to be lengthy and at times certain design decisions that had guided construction had to be overhauled due to regulatory decisions, adding additional time and cost. For example, the top deck of the *Sea Change* was originally designed and built to incorporate a string of glass windows so that passengers visual field would be minimally obstructed (e.g. for viewing the Golden Gate Bridge on a sunset cruise). After multiple rounds of review, the USCG ultimately deemed the top deck fire protection system to be insufficiently safe as originally designed, which required the construction and engineering teams to make design revisions for the elimination of the windows. This entailed developing a revised proposal, submitting that for approval, waiting for the USCG to review and approve, and then finally commencing the work of welding closed the glass windows, installing a sprinkler system, etc. to ensure maximal fire safety (i.e. preventing a fire on the top deck from spreading to the cabin). This is just one of multiple such examples of regulatory hurdles faced by the project team.

While future projects will benefit from the regulatory pathway created by the *Sea Change*, adding ample time to project schedules to accommodate extended review processes with agencies that do not respond to commercial timelines or pressures will nonetheless remain a wise option.

Operation, Repair, Maintenance / Technology Challenges

As the project moved toward commissioning and sea trials, challenges associated with the operation and maintenance of new tech started to reveal themselves. With shifting timelines, coordinating multiple equipment vendors to arrive on-site simultaneously proved to be difficult at times. Generally, given that the owner’s furnished equipment (OFE) installed and integrated on the vessel was provided by multiple independent entities (BAE, Cummins, XALT, GGZEM, AAM), SWITCH was faced with the challenge that there was not one single entity to whom it could ascribe responsibility for all OFE-related tasks. While this complexity of coordination is inherent in many shipbuilding projects and will continue to be a reality as the vessel moves into its operations phase, it is worth highlighting this area to streamline in the future. Such challenges could be alleviated by shipyards managing all subcontractors under business-as-usual circumstances, obtaining full COI rather than only substantial completion from the shipyard before delivery to its intended operating destination, stocking a healthy supply of spare parts on hand in the local geography to eliminate having to make urgent overnight shipment requests from vendors, and training/installing expert

² National Fire Protection Association Hydrogen Technologies Code

³ International Code of Safety for Ships using Gases or other Low-flashpoint Fuels (IGF Code)

resources (electrical engineering, fuel cell system support, etc.) in the local geography to ensure that trained technicians are readily available to support issues as they arise.

Fueling

A hydrogen-fueled vessel is not going anywhere without a robust hydrogen fuel supply chain to deliver the molecule to the tanks onboard. Unlike charging infrastructure, hydrogen affords vessels greater locational flexibility for fueling and can largely parallel existing, well-established truck-to-ship diesel fueling practices in the maritime industry. That said, hydrogen's properties also demand stringent safety measures that mean fueling isn't viable at every location. In Bellingham, WA for instance, the site of fueling was strategically chosen to be located away from public traffic with the ability to establish safety zones based on pre-determined hazardous zones. Aside from locational considerations, sourcing compressed hydrogen from the market at this point in time sometimes requires transporting the molecule long distances, which can add to the delivered \$/kg cost. For sea trials in Bellingham, multiple hydrogen vendors were vetted, from industrial gas suppliers to smaller-scale companies. IGX (now GTL Leasing), the chosen vendor, ultimately ended up transporting hydrogen from California to Washington for use on the *Sea Change*. While hydrogen sourcing may remain a near-term challenge from a cost and logistics perspective, as the hydrogen market matures, the number of sources should increase while the cost is expected to decrease.

Similar to other project categories, SWITCH recommends advanced planning and coordination with permitting agencies in order to obtain the required approvals for hydrogen fueling. Additionally, hosting workshops to educate regulators and the public have been beneficial in dispelling hydrogen myths, fostering greater awareness, and building competency.

Why Hydrogen?

The below serves as an assessment hydrogen's place in the decarbonization trajectory of the commercial harbor craft sector and maritime industry more broadly, leveraging experience from the *Sea Change* project.

SWITCH believes there is no silver bullet solution to solve shipping emissions, and contends that a broad solution set, composed of multiple technologies, will (and needs to) prevail. That said, SWITCH does believe widespread electrification of vessels, hydrogen fuel cells and batteries, will play a particularly critical and important role in decarbonizing certain shipping sectors.

Using electric drives for ship propulsion is not new to the shipping industry, as there are many large ships that use diesel-electric engines (i.e. electric motors powered by a diesel generator that provides the electrons) for decades. The key to decarbonization, therefore, is to (a) transition much of the world's fleet, both big and small, to electric drive, and (b) transition the source of the electrons to zero-carbon power production.

Solving for the latter is where the role of hydrogen (whether stored as pure hydrogen or in some other transportable medium) really starts to shine, especially when combined with battery. Using fuel cells onboard vessels to produce zero-carbon power (with green hydrogen) allows for the vessels to operate like they normally would, without the constraints of just using battery alone.

Energy Intensity / Energy Density

The first important distinction between maritime shipping and other transportation sectors, especially light-duty vehicles on the road, is that ships are extremely energy intensive assets. For a rough sense of scale, a hydrogen fuel cell car or bus might require somewhere between 1 kgs and 50 kgs of H₂ per day for operations, whereas small ferries will require between ~200 kgs and 1,000 kgs per day and larger container ships around 50,000+ kgs per day. In other words, ships often require more than 1000x the energy for operations than some light-duty vehicles.

In order to match a ship's incredibly high energy needs, an energy dense zero-carbon fuel is required. Hydrogen, being a very energy dense molecule (gravimetric energy density of 120 MJ/kg or approximately

3x that of Diesel which is 45.5 MJ/kg), has the ability to power vessels of all types that are required to travel far distances or fast speeds while producing zero emissions.

Energy Storage, Power, and Scalability

A key distinction between batteries and hydrogen fuel cell systems is that batteries aggregate energy storage and power output into one physical unit, while hydrogen systems disaggregate them with fuel cells providing power output and hydrogen tanks providing energy storage. Partly as a result of this separation, hydrogen systems are able to scale without running into some of the space and weight issues that batteries have.

As a concrete data point, SWITCH's hydrogen fuel cell ferry *Sea Change* has 246 kgs of hydrogen storage on its top deck, which equates to ~8,200 kWh of energy. Fitting 8.2 MWh of battery onboard the same ferry would be impossible due to both space and weight limitations. Similarly, while powering the biggest ships in the world with only battery would be impossible with today's technology, the International Council on Clean Transportation published a paper in 2020 on containerships servicing the US China corridor finding that, "99% of the voyages made along the [US – China] corridor in 2015 can be powered by hydrogen with only minor changes to fuel capacity or operations..."⁴ In other words, the same basic hydrogen fuel cell powertrain architecture that is on the *Sea Change* ferry could power much larger vessels.

While hydrogen may be the best available zero-carbon option for most energy intensive ships, there is still room for innovation. Specifically, while hydrogen has a high energy density by weight (as mentioned above) it has a lower volumetric energy density than conventional hydrocarbon fuels, which means that hydrogen still takes up relatively more space for the same amount of energy storage. Current hydrogen storage methods involve compressing or liquefying the gas to achieve volumetric energy densities of approximately ¼ that of diesel (i.e. requires ~4x more space to store the same energy). R&D in this area is underway exploring alternative means of hydrogen storage in other forms that achieve higher volumetric energy densities. Compressed hydrogen was intentionally chosen for the *Sea Change* as it stores enough energy for ferry operations and acts as a first step to establish the regulatory foundation for hydrogen use in maritime applications.

Efficiency

Some contend that batteries are preferable to hydrogen because of the efficiency losses in hydrogen production and use. In other words, why would one want to start with electricity produced by a solar panel or wind turbine, to then split water to create hydrogen, to then convert back into electricity through a fuel cell to power an electric motor, when one could just store the electricity generated by the solar panel or wind turbine directly in a battery? While these efficiency losses do exist, the practical ability to fit enough energy in batteries onboard a ship to power voyages often runs up against space and weight constraints that simply render it an impossible option and leave hydrogen as the best available zero-carbon solution.

For select routes with relatively low energy requirements and frequent charging opportunities, batteries may indeed be the right answer. Further, batteries may be beneficial when used in conjunction with fuel cells, providing the ability to boost and regulate the baseload power provided by the fuel cells for short durations of time.

⁴ <https://theicct.org/publications/zero-emission-container-corridor-hydrogen-2020>

Established Architectures and Fueling Procedures

As mentioned above, many vessels in the maritime industry are diesel-electric, which has created familiarity with electric propulsion systems. The introduction of hydrogen fuel cell powertrains is not a radical departure from such existing diesel-electric designs, just a replacement of diesel generators with fuel cells.

Similarly, on the land side, hydrogen fueling parallels established procedures in the maritime shipping industry with other fuels such as liquefied natural gas. Hydrogen can be delivered to ships via mobile trucking solutions or eventually via bunker barges for larger ships, paralleling existing operations. Further, these means of fueling do not require the installation of large-scale shoreside charging infrastructure or changes in operational profiles to accommodate charging times that would be associated with battery-only vessels.

Discussion of future applications and commercialization prospects

SWITCH is considering additional commercial opportunities to build additional zero-emission ferries against long-term charters, starting with a focus in the CA market.

Broadly, SWITCH's approach to technology development and commercialization may be summarized as follows:

- SWITCH believes electrification, using both hydrogen fuel cell and battery, has the potential to address “hard-to-decarbonize” high horsepower transportation sectors, including maritime shipping. This thesis is becoming more widely accepted by industry and the investor population.
- SWITCH believes transforming the shipping industry and achieving gigaton-scale emissions reductions requires pioneering the vessel fleets of the future to catalyze widespread adoption of zero-emissions technology.
- SWITCH develops fuel-switching opportunities in collaboration with existing ship operators, enabling the replacement of carbon-intensive diesel-powered fleets with the next generation of zero-emissions vessels paired with the supporting clean-fuel distribution partnerships (e.g. H2 delivery, electric charging, etc.) to power those vessels.
- SWITCH sees ferries as an ideal starting point for adoption of zero emissions technology in the maritime industry because they are generally characterized by:
 - Relatively short routes, with relatively low energy requirements and requiring less fuel onboard
 - Consistent operational schedules, allowing for easier-to-implement fueling/charging schedules
 - Single-homeport harbor craft, that return to the same terminal (and fueling location) each day
 - An aging US ferry fleet, with roughly 900 ferries in operation that are average >30 years old
 - Upcoming renewal of assets that are 10+ years past their useful life (typically 20 years)
 - Critical public transportation infrastructure for municipalities that are under increasing pressure to decarbonize public transportation fleets (i.e. electric buses, etc.)
 - Visible to the public, often subject to more public environmental scrutiny than other vessel types
 - Considered “low hanging fruit” to regulators, suggesting that emissions regulations will impact ferries imminently
 - Operators that are not well capitalized, or working within difficult government capital budgets
 - Operators that don't have technical expertise with installing or building with H2/electric systems
 - Operators that rely on availability of diesel commodity market, with clean fueling infrastructure
 - Operating near city “demand centers” where clean fueling infrastructure can access multiple markets
- SWITCH aims to facilitate ferry operators' transition by offering them capital-efficient access to zero-emissions vessels through bareboat lease.
- By offering bareboat charters as well as clean-fueling partnership solutions for ferries, SWITCH does not compete with existing operators, but rather simplifies, de-risks, and lowers the barriers to their adoption of the zero-emissions technology they need for compliance.

Ultimately, SWITCH sees other commercial harbor craft vessel types (e.g. tugs, offshore windfarm service vessels, etc.) as candidates for a transition to zero emissions power for compliance, and plans to cooperate with technology partners to scale the same core technology implemented in Vessel #1 to larger ferries and higher horsepower vessel types. While these larger vessel types represent compelling opportunities for securing long-term contracted cash flows, SWITCH is going to remain commercially focused solely on passenger ferries in its initial phase of growth.

While maintaining commercial dialogues underway in non-California and non-US ferry markets, SWITCH will concentrate commercial efforts in the California market where it has built credibility and valuable relationships with the parties looking to procure zero emission vessels to meet the CHC regulation.

The immediate growth plan for SWITCH is to progress to a 150-passenger fuel cell electric ferry design capable of achieving speeds of ~25 knots, leveraging many of the lessons learned with the *Sea Change*. SWITCH is currently aiming to be under construction on its first 150-passenger by the end of 2024 with commercialization prospects in California and beyond.